

HX220 L

ENGINE			
Maker / Model	Cummins QSB6.7		
Type	4-cycle turbocharged, charge air cooled diesel engine		
Rated flywheel horse power	SAE	J1995 (gross)	136 kW (182.6 HP) at 1,950 rpm
		J1349 (net)	129 kW (173 HP) at 1,950 rpm
	DIN	6271/1 (gross)	136 kW (185 PS) at 1,950 rpm
		6271/1 (net)	129 kW (175 PS) at 1,950 rpm
Max. torque	85.7 kgf·m (620 lbf·ft) at 1,500 rpm		
Bore x stroke	107 x 124 mm (4.21" x 4.88")		
Piston displacement	6,700 cc (409 cu in)		
Batteries	2 x 12 V x 100 Ah		
Starting motor	Denso 24 V - 4.8 kW		
Alternator	Denso 24 V - 95 A		

HYDRAULIC SYSTEM

MAIN PUMP	
Type	Variable displacement tandem axis piston pumps
Max. flow	2 x 222 l/min
Sub-pump for pilot circuit	Gear pump

Cross-sensing and fuel saving pump system

HYDRAULIC MOTORS

Travel	Two speed axial pistons motor with brake valve and parking brake
Swing	Axial piston motor with automatic brake

RELIEF VALVE SETTING

Implement circuits	350 kgf/cm ² (4,980 psi)
Travel	350 kgf/cm ² (4,980 psi)
Power boost (boom, arm, bucket)	380 kgf/cm ² (5,400 psi)
Swing circuit	265 kgf/cm ² (3,770 psi)
Pilot circuit	40 kgf/cm ² (570 psi)
Service valve	Installed

HYDRAULIC CYLINDERS

No. of cylinder bore x stroke	Boom: Ø 120 x 1,290 mm
	2-Piece Boom: Ø 160 x 1,060 mm
	Arm: Ø 140 x 1,510 mm
	Bucket: Ø 120 x 1,055 mm

DRIVES & BRAKES

Drive method	Fully hydrostatic type
Drive motor	Axial piston motor, in-shoe design
Reduction system	Planetary reduction gear
Max. drawbar pull	20,200 kgf (44,530 lbf)
Max. travel speed (high / low)	5.5 km/hr (3.41 mph) / 3.6 km/hr (2.23 mph)
Gradeability	35° (70%)
Parking brake	Multi wet disc

CONTROL

Pilot pressure operated joysticks and pedals with detachable lever provide almost effortless and fatigueless operation.

Pilot control	Two joysticks with one safety lever (LH): Swing and arm (RH): Boom and bucket (ISO)
Traveling and steering	Two levers with pedals
Engine throttle	Electric, Dial type

SWING SYSTEM

Swing motor	Fixed displacement axial piston motor
Swing reduction	Planetary gear reduction
Swing bearing lubrication	Grease-bathed
Swing brake	Multi wet disc
Swing speed	10.8 rpm

SERVICE REFILL CAPACITIES

Re-filling	liter	US gal	UK gal
Fuel tank	400	106	88
Engine coolant	40	10.6	8.8
Engine oil	23	6.1	5.06
Swing device	6.2	1.64	1.36
Final drive (each)	4.5	1.2	1
Hydraulic system (including tank)	275	72.6	60.5
Hydraulic tank	160	42.3	35.2
DEF/AdBlue®	27	7.1	5.9

UNDERCARRIAGE

The X-leg type center frame is integrally welded with reinforced box-section track frames. The undercarriage includes lubricated rollers, idlers, track adjusters with shock absorbing springs and sprockets and a track chain with double or triple grouser shoes.

Center frame	X - leg type
Track frame	Pentagonal box type
No. of shoes on each side	49 EA
No. of carrier roller on each side	2 EA
No. of track roller on each side	9 EA
No. of rail guard on each side	2 EA

OPERATING WEIGHT (APPROXIMATE)

Operating weight, including 5,680 mm (18' 8") boom; 2,920 mm (9' 7") arm; SAE heaped 0.92 m³ (1.20 yd³) bucket, lubricant, coolant, full fuel tank, full hydraulic tank and all standard equipments.

OPERATING WEIGHT

Shoes	Operating weight		Ground pressure	
	Width mm (in)	kg (lb)		kgf / cm ² (psi)
Triple grouser	600 (24")	HX220 L	22,100 (48,720)	0.47 (6.68)
		HX220 L HW	23,560 (51,940)	0.50 (7.11)
	700 (28")	HX220 L	22,380 (49,340)	0.41 (5.83)
		HX220 L HW	23,840 (52,560)	0.44 (6.26)
	800 (32")	HX220 L	22,660 (49,960)	0.36 (5.12)
		HX220 L HW	24,120 (53,170)	0.39 (5.55)
900 (36")	HX220 L	22,940 (50,570)	0.33 (4.69)	
	HX220 L HW	24,400 (53,790)	0.35 (4.98)	
Double grouser	600 (24")	HX220 L HW	23,690 (52,230)	0.50 (7.11)
	700 (28")	HX220 L HW	24,040 (53,000)	0.43 (6.11)

HX220 NL

ENGINE			
Maker / Model	Cummins QSB6.7		
Type	4-cycle turbocharged, charge air cooled diesel engine		
Rated flywheel horse power	SAE	J1995 (gross)	136 kW (182.6 HP) at 1,950 rpm
		J1349 (net)	129 kW (173 HP) at 1,950 rpm
	DIN	6271/1 (gross)	136 kW (185 PS) at 1,950 rpm
		6271/1 (net)	129 kW (175 PS) at 1,950 rpm
Max. torque	85.7 kgf·m (620 lbf·ft) at 1,500 rpm		
Bore x stroke	107 x 124 mm (4.21" x 4.88")		
Piston displacement	6,700 cc (409 cu in)		
Batteries	2 x 12 V x 100 Ah		
Starting motor	Denso 24 V - 4.8 kW		
Alternator	Denso 24 V - 95 A		

HYDRAULIC SYSTEM

MAIN PUMP	
Type	Variable displacement tandem axis piston pumps
Max. flow	2 x 222 l/min
Sub-pump for pilot circuit	Gear pump

Cross-sensing and fuel saving pump system

HYDRAULIC MOTORS

Travel	Two speed axial pistons motor with brake valve and parking brake
Swing	Axial piston motor with automatic brake

RELIEF VALVE SETTING

Implement circuits	350 kgf/cm ² (4,980 psi)
Travel	350 kgf/cm ² (4,980 psi)
Power boost (boom, arm, bucket)	380 kgf/cm ² (5,400 psi)
Swing circuit	265 kgf/cm ² (3,770 psi)
Pilot circuit	40 kgf/cm ² (570 psi)
Service valve	Installed

HYDRAULIC CYLINDERS

No. of cylinder bore x stroke	Boom: Ø 120 x 1,290 mm
	2-Piece Boom: Ø 160 x 1,060 mm
	Arm: Ø 140 x 1,510 mm
	Bucket: Ø 120 x 1,055 mm

DRIVES & BRAKES

Drive method	Fully hydrostatic type
Drive motor	Axial piston motor, in-shoe design
Reduction system	Planetary reduction gear
Max. drawbar pull	20,200 kgf (44,530 lbf)
Max. travel speed (high / low)	5.5 km/hr (3.41 mph) / 3.6 km/hr (2.23 mph)
Gradeability	35° (70%)
Parking brake	Multi wet disc

CONTROL

Pilot pressure operated joysticks and pedals with detachable lever provide almost effortless and fatigueless operation.

Pilot control	Two joysticks with one safety lever (LH): Swing and arm (RH): Boom and bucket (ISO)
Traveling and steering	Two levers with pedals
Engine throttle	Electric, Dial type

SWING SYSTEM

Swing motor	Fixed displacement axial piston motor
Swing reduction	Planetary gear reduction
Swing bearing lubrication	Grease-bathed
Swing brake	Multi wet disc
Swing speed	10.8 rpm

SERVICE REFILL CAPACITIES

Re-filling	liter	US gal	UK gal
Fuel tank	310	81.9	68.2
Engine coolant	40	10.6	8.8
Engine oil	23.7	6.3	5.2
Swing device	6.2	1.64	1.36
Final drive (each)	4.5	1.2	1
Hydraulic system (including tank)	340	89.8	74.8
Hydraulic tank	165	43.6	36.3
DEF/AdBlue®	27	7.1	5.9

UNDERCARRIAGE

The X-leg type center frame is integrally welded with reinforced box-section track frames. The undercarriage includes lubricated rollers, idlers, track adjusters with shock absorbing springs and sprockets and a track chain with double or triple grouser shoes.

Center frame	X - leg type
Track frame	Pentagonal box type
No. of shoes on each side	49 EA
No. of carrier roller on each side	2 EA
No. of track roller on each side	9 EA
No. of rail guard on each side	2 EA

OPERATING WEIGHT (APPROXIMATE)

Operating weight, including 5,650 mm (18' 6") boom; 2,920 mm (9' 7") arm; SAE heaped 0.87 m³ (1.14 yd³) bucket, lubricant, coolant, full fuel tank, full hydraulic tank and all standard equipments.

OPERATING WEIGHT



Shoes	Operating weight		Ground pressure
	Width mm (in)	kg (lb)	
Triple grouser	500 (20")	HX220 NL 22,300 (49,160)	0.57 (8.11)
	600 (24")	HX220 NL 22,400 (49,380)	0.48 (6.83)
	700 (28")	HX220 NL 22,870 (50,420)	0.42 (5.97)

BUCKET SELECTION GUIDE & DIGGING FORCE

HX220 L / NL

HX220 L

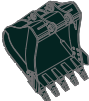
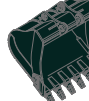
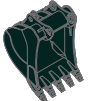
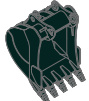
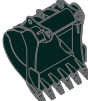
BUCKETS

						
SAE heaped m ³ (yd ³)	0.80 (1.05) 0.92 (1.20) 1.10 (1.44) 1.20 (1.57)	1.34 (1.75)	◆ 0.90 (1.18) ◆ 1.05 (1.37)	◆ 0.87 (1.14)	◆ 1.20 (1.57)	★ 0.52 (0.68)

Capacity m ³ (yd ³)		Width mm (in)		Weight kg (lb)	Recommendation mm (ft.in)							
					5,680 (18' 8") Boom				5,650 (18' 6") 2-Piece Boom			8,200 (26' 11") Boom
SAE heaped	CECE heaped	Without side cutters	With side cutters		2,000 (6' 7") Arm	2,400 (7' 10") Arm	2,920 (9' 7") Arm	3,900 (12' 10") Arm	2,000 (6' 7") Arm	2,400 (7' 10") Arm	2,920 (9' 7") Arm	6,300 (20' 8") Arm
0.80 (1.05)	0.70 (0.92)	1,070 (42.1)	1,160 (45.7)	770 (1,700)	●	●	●	○	●	●	◎	-
0.92 (1.20)	0.80 (1.05)	1,190 (46.9)	1,280 (50.4)	820 (1,810)	●	●	●	○	●	●	◎	-
1.10 (1.44)	0.96 (1.26)	1,375 (54.1)	1,465 (57.7)	890 (1,960)	●	●	◎	○	●	◎	○	-
1.20 (1.57)	1.05 (1.37)	1,390 (54.7)	1,480 (58.3)	920 (2,030)	●	◎	○	-	●	◎	-	-
1.34 (1.75)	1.17 (1.53)	1,525 (60.0)	1,615 (63.6)	990 (2,180)	◎	◎	○	-	◎	○	-	-
◆ 0.90 (1.18)	0.79 (1.03)	1,210 (47.6)	-	880 (1,940)	●	●	●	○	●	●	◎	-
◆ 1.05 (1.37)	0.92 (1.20)	1,355 (53.3)	-	940 (2,070)	●	●	◎	○	●	◎	○	-
◆ 0.87 (1.14)	0.77 (1.01)	1,195 (47.0)	-	940 (2,070)	●	●	●	○	●	●	◎	-
◆ 1.20 (1.57)	1.05 (1.37)	1,520 (59.8)	-	1,120 (2,470)	◎	○	-	-	◎	○	-	-
★ 0.52 (0.68)	0.45 (0.59)	945 (37.2)	1,020 (40.2)	460 (1,010)	-	-	-	-	-	-	-	◎

- ◆ Heavy duty bucket
- ◆ Rock-Heavy duty bucket
- ★ Long reach bucket

- : Applicable for materials with density of 2,000 kg /m³ (3,370 lb/ yd³) or less
- ◎ : Applicable for materials with density of 1,600 kg /m³ (2,700 lb/ yd³) or less
- : Applicable for materials with density of 1,100 kg /m³ (1,850 lb/ yd³) or less

ATTACHMENT

Booms and arms are welded with a low-stress, full-box section design.
5.68 m (18' 8") & 8.2 m (26' 11") Booms and 5.65 m (18' 6") 2-Piece Boom and 2.0 m (6' 7"); 2.4 m (7' 10"); 2.92 m (9' 7"); 3.9 m (12' 10") & 6.3 m (20' 8") Arms are available.

DIGGING FORCE

Boom	Length	mm (ft.in)	Boom 5,680 (18' 8")				2-Piece Boom 5,650 (18' 6")			8,200 (26' 11")	Remarks:
	Weight	kg (lb)	1,950 (4,300)				2,600 (5,730)			2,350 (5,180)	
Arm	Length	mm (ft.in)	2,000 (6' 7")	2,400 (7' 10")	2,920 (9' 7")	3,900 (12' 10")	2,000 (6' 7")	2,400 (7' 10")	2,920 (9' 7")	6,300 (20' 8")	[]: Power Boost
	Weight	kg (lb)	975 (2,150)	1,045 (2,300)	1,095 (2,410)	1,295 (2,850)	975 (2,150)	1,045 (2,300)	1,095 (2,410)	1,330 (2,930)	
Bucket digging force	SAE	kN	133.4 [144.8]	133.4 [144.8]	133.4 [144.8]	133.4 [144.8]	133.4 [144.8]	133.4 [144.8]	133.4 [144.8]	72.6	
		kgf	13600 [14770]	13600 [14770]	13600 [14770]	13600 [14770]	13600 [14770]	13600 [14770]	13600 [14770]	7400	
		lbf	29980 [32550]	29980 [32550]	29980 [32550]	29980 [32550]	29980 [32550]	29980 [32550]	29980 [32550]	16310	
	ISO	kN	152.0 [165.0]	152.0 [165.0]	152.0 [165.0]	152.0 [165.0]	152.0 [165.0]	152.0 [165.0]	152.0 [165.0]	83.4	
		kgf	15500 [16830]	15500 [16830]	15500 [16830]	15500 [16830]	15500 [16830]	15500 [16830]	15500 [16830]	8500	
		lbf	34170 [37100]	34170 [37100]	34170 [37100]	34170 [37100]	34170 [37100]	34170 [37100]	34170 [37100]	18740	
Arm crowd force	SAE	kN	144.2 [156.5]	119.6 [129.9]	102.0 [110.7]	84.3 [91.6]	144.2 [156.5]	119.6 [129.9]	102.0 [110.7]	49.0	
		kgf	14700 [15960]	12200 [13250]	10400 [11290]	8600 [9340]	14700 [15960]	12200 [13250]	10400 [11290]	5000	
		lbf	32410 [35190]	26900 [29210]	22930 [24900]	18960 [20590]	32410 [35190]	26900 [29210]	22930 [24900]	11020	
	ISO	kN	151.0 [164.0]	125.5 [136.3]	106.9 [116.1]	87.3 [94.8]	151.0 [164.0]	125.5 [136.3]	106.9 [116.1]	50.0	
		kgf	15400 [16720]	12800 [13900]	10900 [11830]	8900 [9660]	15400 [16720]	12800 [13900]	10900 [11830]	5100	
		lbf	33950 [36860]	28220 [30640]	24030 [26090]	19620 [21300]	33950 [36860]	28220 [30640]	24030 [26090]	11240	



Note : Boom weight includes arm cylinder, piping, and pin
Arm weight includes bucket cylinder, linkage, and pin

BUCKET SELECTION GUIDE & DIGGING FORCE

HX220 L/NL

HX220 NL

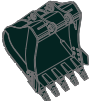
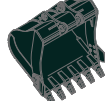
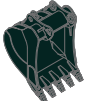
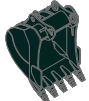
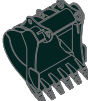
BUCKETS

						
SAE heaped m ³ (yd ³)	0.80 (1.05) 0.92 (1.20) 1.10 (1.44) 1.20 (1.57)	1.34 (1.75)	◆ 0.90 (1.18) ◆ 1.05 (1.37)	◆ 0.87 (1.14)	◆ 1.20 (1.57)	★ 0.52 (0.68)

Capacity m ³ (yd ³)		Width mm (in)		Weight kg (lb)	Recommendation mm (ft.in)					
					5,650 (18' 6") Boom			5,650 (18' 6") 2-Piece Boom		
SAE heaped	CECE heaped	Without side cutters	With side cutters		2,000 (6' 7") Arm	2,400 (7' 10") Arm	2,920 (9' 7") Arm	2,000 (6' 7") Arm	2,400 (7' 10") Arm	2,920 (9' 7") Arm
0.80 (1.05)	0.70 (0.92)	1,070 (42.1)	1,160 (45.7)	770 (1,700)	●	●	●	●	●	⊙
0.92 (1.20)	0.80 (1.05)	1,190 (46.9)	1,280 (50.4)	820 (1,810)	●	●	●	●	●	⊙
1.10 (1.44)	0.96 (1.26)	1,375 (54.1)	1,465 (57.7)	890 (1,960)	●	●	⊙	●	⊙	○
1.20 (1.57)	1.05 (1.37)	1,390 (54.7)	1,480 (58.3)	920 (2,030)	●	⊙	○	●	⊙	-
1.34 (1.75)	1.17 (1.53)	1,525 (60.0)	1,615 (63.6)	990 (2,180)	⊙	⊙	○	⊙	○	-
◆ 0.90 (1.18)	0.79 (1.03)	1,210 (47.6)	-	880 (1,940)	●	●	●	●	●	⊙
◆ 1.05 (1.37)	0.92 (1.20)	1,355 (53.3)	-	940 (2,070)	●	●	⊙	●	⊙	○
◆ 0.87 (1.14)	0.77 (1.01)	1,195 (47.0)	-	940 (2,070)	●	●	●	●	●	⊙
◆ 1.20 (1.57)	1.05 (1.37)	1,520 (59.8)	-	1,120 (2,470)	⊙	○	-	⊙	○	-
★ 0.52 (0.68)	0.45 (0.59)	945 (37.2)	1,020 (40.2)	460 (1,010)	-	-	-	-	-	-

- ◆ Heavy duty bucket
- ◆ Rock-Heavy duty bucket
- ★ Long reach bucket

- : Applicable for materials with density of 2,000 kg /m³ (3,370 lb/ yd³) or less
- ⊙ : Applicable for materials with density of 1,600 kg /m³ (2,700 lb/ yd³) or less
- : Applicable for materials with density of 1,100 kg /m³ (1,850 lb/ yd³) or less

ATTACHMENT

Booms and arms are welded with a low-stress, full-box section design.
5.65 m (18' 6") Boom & 5.65 m (18' 6") 2-Piece Boom and 2.0 m (6' 7"); 2.4 m (7' 10") & 2.92 m (9' 7") Arms are available.

DIGGING FORCE

Boom	Length	mm (ft.in)	Boom 5,650 (18' 6")				2-Piece Boom 5,650 (18' 6")			Remarks:
	Weight	kg (lb)	1,950 (4,300)				2,600 (5,730)			
Arm	Length	mm (ft.in)	2,000 (6' 7")	2,400 (7' 10")	2,920 (9' 7")	3,900 (12' 10")	2,000 (6' 7")	2,400 (7' 10")	2,920 (9' 7")	[] : Power Boost
	Weight	kg (lb)	975 (2,150)	1,045 (2,300)	1,095 (2,410)	1,295 (2,850)	975 (2,150)	1,045 (2,300)	1,095 (2,410)	
Bucket digging force	SAE	kN	133.4 [144.8]	133.4 [144.8]	133.4 [144.8]	133.4 [144.8]	133.4 [144.8]	133.4 [144.8]	133.4 [144.8]	
		kgf	13600 [14770]	13600 [14770]	13600 [14770]	13600 [14770]	13600 [14770]	13600 [14770]	13600 [14770]	
		lbf	29980 [32550]	29980 [32550]	29980 [32550]	29980 [32550]	29980 [32550]	29980 [32550]	29980 [32550]	
	ISO	kN	152.0 [165.0]	152.0 [165.0]	152.0 [165.0]	152.0 [165.0]	152.0 [165.0]	152.0 [165.0]	152.0 [165.0]	
		kgf	15500 [16830]	15500 [16830]	15500 [16830]	15500 [16830]	15500 [16830]	15500 [16830]	15500 [16830]	
		lbf	34170 [37100]	34170 [37100]	34170 [37100]	34170 [37100]	34170 [37100]	34170 [37100]	34170 [37100]	
Arm crowd force	SAE	kN	144.2 [156.5]	119.6 [129.9]	102.0 [110.7]	84.3 [91.6]	144.2 [156.5]	119.6 [129.9]	102.0 [110.7]	
		kgf	14700 [15960]	12200 [13250]	10400 [11290]	8600 [9340]	14700 [15960]	12200 [13250]	10400 [11290]	
		lbf	32410 [35190]	26900 [29210]	22930 [24900]	18960 [20590]	32410 [35190]	26900 [29210]	22930 [24900]	
	ISO	kN	151.0 [164.0]	125.5 [136.3]	106.9 [116.1]	87.3 [94.8]	151.0 [164.0]	125.5 [136.3]	106.9 [116.1]	
		kgf	15400 [16720]	12800 [13900]	10900 [11830]	8900 [9660]	15400 [16720]	12800 [13900]	10900 [11830]	
		lbf	33950 [36860]	28220 [30640]	24030 [26090]	19620 [21300]	33950 [36860]	28220 [30640]	24030 [26090]	

Note : Boom weight includes arm cylinder, piping, and pin
Arm weight includes bucket cylinder, linkage, and pin

DIMENSIONS & WORKING RANGE

HX220 L / NL

HX220 L DIMENSIONS

5.68 m (18' 8") BOOM and 2.0 m (6' 7"); 2.4 m (7' 10"); 2.92 m (9' 7") & 3.9 m (12' 10") ARM

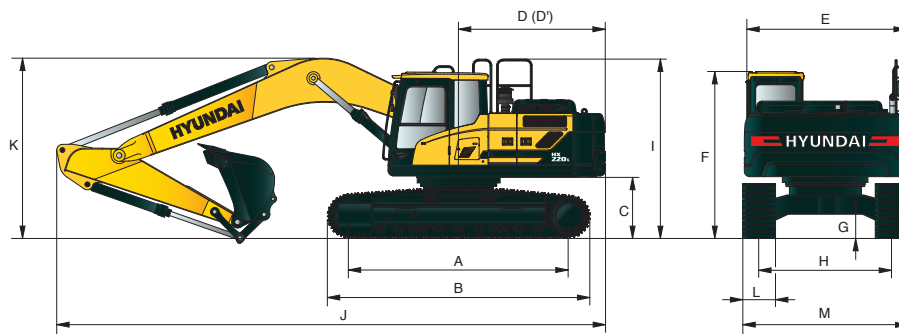

Unit : mm (ft-in)

A	Tumbler distance	3,650 (12' 0")
B	Overall length of crawler	4,404 (14' 4")
C	Ground clearance of counterweight	1,060 (3' 6")
D	Tail swing radius	2,890 (9' 5")
D'	Rear-end length	2,770 (9' 1")
E	Overall width of upperstructure	2,740 (9' 0")
F	Overall height of cab	3,000 (9' 8")
G	Min. ground clearance	480 (1' 7")
H	Track gauge	2,390 (7' 10")
I	Overall height of guardrail	3,210 (10' 5")

Boom length	5,680 (18' 8")			
Arm length	2,000 (6' 7")	2,400 (7' 10")	2,920 (9' 7")	3,900 (12' 10")
J Overall length	9,650 (31' 8")	9,570 (31' 5")	9,530 (31' 3")	9,520 (31' 3")
K Overall height of boom	3,200 (10' 6")	3,110 (10' 2")	3,030 (9' 11")	3,480 (11' 5")
L Track shoe width	600 (24")	700 (28")	800 (32")	900 (36")
M Overall width	2,990 (9' 10")	3,090 (10' 2")	3,190 (10' 6")	3,290 (10' 10")

HX220 L WORKING RANGE

Unit : mm (ft-in)

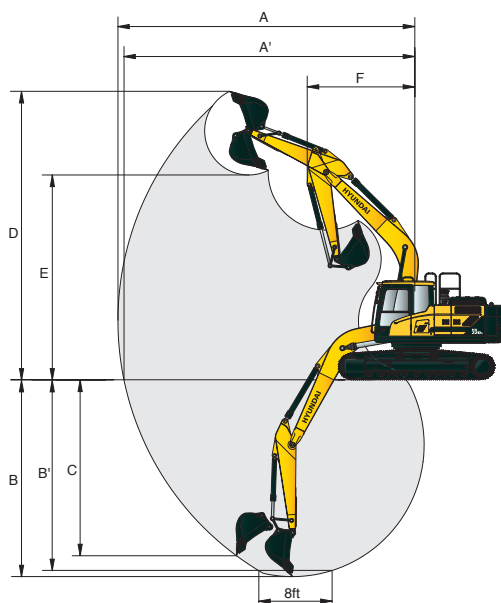

Boom length	5,680 (18' 8")			
Arm length	2,000 (6' 7")	2,400 (7' 10")	2,920 (9' 7")	3,900 (12' 10")
A Max. digging reach	9,140 (30' 0")	9,500 (31' 2")	9,980 (32' 9")	10,910 (35' 10")
A' Max. digging reach on ground	8,960 (29' 5")	9,330 (30' 7")	9,820 (32' 3")	10,770 (35' 4")
B Max. digging depth	5,820 (19' 1")	6,220 (20' 5")	6,730 (22' 1")	7,720 (25' 4")
B' Max. digging depth (8' level)	5,580 (18' 4")	6,010 (19' 9")	6,560 (21' 6")	7,580 (24' 10")
C Max. vertical wall digging depth	5,280 (17' 4")	5,720 (18' 9")	6,280 (20' 7")	7,240 (23' 9")
D Max. digging height	9,140 (30' 0")	9,340 (30' 8")	9,600 (31' 6")	10,110 (33' 2")
E Max. dumping height	6,330 (20' 9")	6,520 (21' 5")	6,780 (22' 3")	7,290 (23' 11")
F Min. front swing radius	3,750 (12' 4")	3,740 (12' 3")	3,670 (12' 0")	3,700 (12' 2")

DIMENSIONS & WORKING RANGE

HX220 L / NL

HX220 L 2-PIECE BOOM DIMENSIONS

5.65 m (18' 6") 2-Piece BOOM and 2.0 m (6' 7"); 2.4 m (7' 10") & 2.92 m (9' 7") ARM

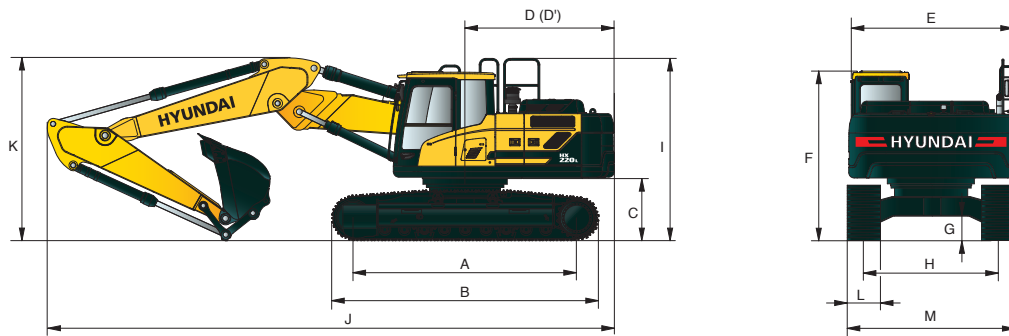

Unit : mm (ft-in)

A	Tumbler distance	3,650 (12' 0")
B	Overall length of crawler	4,404 (14' 4")
C	Ground clearance of counterweight	1,060 (3' 6")
D	Tail swing radius	2,890 (9' 5")
D'	Rear-end length	2,770 (9' 1")
E	Overall width of upperstructure	2,740 (9' 0")
F	Overall height of cab	3,000 (9' 8")
G	Min. ground clearance	480 (1' 7")
H	Track gauge	2,390 (7' 10")
I	Overall height of guardrail	3,210 (10' 5")

Boom length	5,650 (18' 6") 2-Piece Boom			
Arm length	2,000 (6' 7")	2,400 (7' 10")	2,920 (9' 7")	
J Overall length	9,650 (31' 8")	9,570 (31' 5")	9,530 (31' 3")	
K Overall height of boom	3,200 (10' 6")	3,110 (10' 2")	3,030 (9' 11")	
L Track shoe width	600 (24")	700 (28")	800 (32")	900 (36")
M Overall width	2,990 (9' 10")	3,090 (10' 2")	3,190 (10' 6")	3,290 (10' 10")

HX220 L 2-PIECE BOOM WORKING RANGE

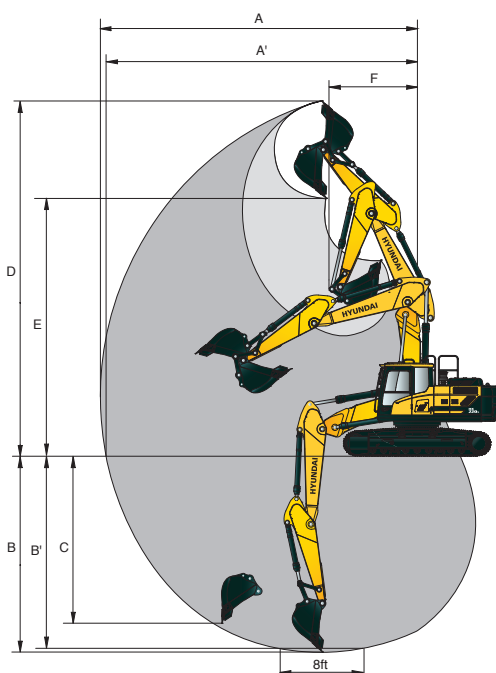

Unit : mm (ft-in)

Boom length	5,650 (18' 6") 2-Piece Boom			
Arm length	2,000 (6' 7")	2,400 (7' 10")	2,920 (9' 7")	
A Max. digging reach	9,120 (29' 11")	9,530 (31' 3")	10,020 (32' 10")	
A' Max. digging reach on ground	8,950 (29' 4")	9,360 (30' 8")	9,860 (32' 4")	
B Max. digging depth	5,820 (19' 1")	5,880 (19' 3")	6,400 (21' 0")	
B' Max. digging depth (8' level)	5,480 (18' 0")	5,770 (18' 11")	6,290 (20' 8")	
C Max. vertical wall digging depth	5,360 (17' 7")	5,020 (16' 6")	5,560 (18' 3")	
D Max. digging height	10,310 (33' 10")	10,670 (35' 0")	11,090 (36' 5")	
E Max. dumping height	7,390 (24' 3")	7,750 (25' 5")	8,160 (26' 9")	
F Min. front swing radius	2,870 (9' 5")	2,660 (8' 9")	2,530 (8' 4")	

DIMENSIONS & WORKING RANGE

HX220 L/NL

HX220 L LONG REACH DIMENSIONS

8.2 m (26' 11") BOOM and 6.3 m (20' 8") ARM

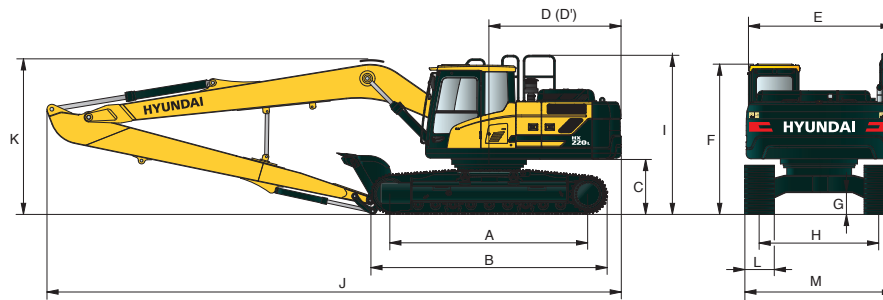

Unit : mm (ft-in)

A	Tumbler distance	3,650 (12' 0")
B	Overall length of crawler	4,404 (14' 4")
C	Ground clearance of counterweight	1,060 (3' 6")
D	Tail swing radius	2,890 (9' 5")
D'	Rear-end length	2,770 (9' 1")
E	Overall width of upperstructure	2,740 (9' 0")
F	Overall height of cab	3,000 (9' 8")
G	Min. ground clearance	480 (1' 7")
H	Track gauge	2,390 (7' 10")
I	Overall height of guardrail	3,210 (10' 5")

	Boom length	8,200 (26' 11")
	Arm length	6,300 (20' 8")
J	Overall length	12,030 (39' 6")
K	Overall height of boom	3,280 (10' 9")
L	Track shoe width	800 (32")
M	Overall width	3,190 (10' 6")

HX220 L LONG REACH WORKING RANGE

Unit : mm (ft-in)

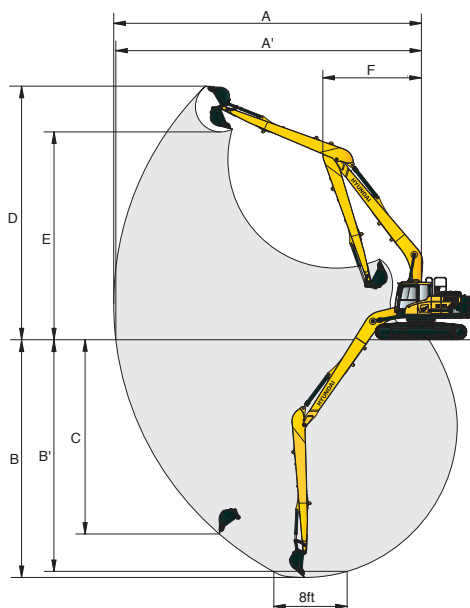

	Boom length	8,200 (26' 11")
	Arm length	6,300 (20' 8")
A	Max. digging reach	15,220 (50' 0")
A'	Max. digging reach on ground	15,120 (49' 7")
B	Max. digging depth	11,760 (38' 7")
B'	Max. digging depth (8° level)	11,650 (38' 3")
C	Max. vertical wall digging depth	9,610 (31' 6")
D	Max. digging height	12,550 (41' 2")
E	Max. dumping height	10,280 (33' 8")
F	Min. front swing radius	4,870 (16' 0")

DIMENSIONS & WORKING RANGE

HX220 L / NL

HX220 L HIGH WALKER DIMENSIONS

5.68 m (18' 8") BOOM and 2.0 m (6' 7"); 2.4 m (7' 10") & 2.92 m (9' 7") ARM

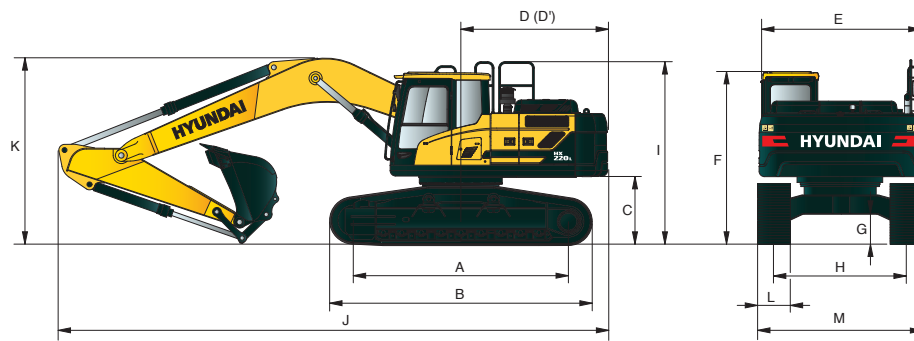

Unit : mm (ft-in)

A	Tumbler distance	3,650 (12' 0")
B	Overall length of crawler	4,404 (14' 4")
C	Ground clearance of counterweight	1,260 (4' 1")
D	Tail swing radius	2,890 (9' 5")
D'	Rear-end length	2,770 (9' 1")
E	Overall width of upperstructure	2,740 (9' 0")
F	Overall height of cab	3,200 (10' 5")
G	Min. ground clearance	660 (2' 2")
H	Track gauge	2,795 (9' 2")
I	Overall height of guardrail	3,410 (11' 2")

Boom length		5,680 (18' 8")					
Arm length		2,000 (6' 7")	2,400 (7' 10")	2,920 (9' 7")	3,900 (12' 10")		
J	Overall length	9,650 (31' 8")	9,550 (31' 4")	9,470 (31' 1")	9,560 (31' 4")		
K	Overall height of boom	3,290 (10' 10")	3,170 (10' 5")	3,060 (10' 0")	3,450 (11' 4")		
L	Track shoe	type	Triple grouser		Double grouser		
		width	600 (24")	700 (28")	800 (32")	900 (36")	600 (24")
M	Overall width	3,395 (11' 2")	3,495 (11' 6")	3,595 (11' 10")	3,695 (12' 2")	3,395 (11' 2")	3,495 (11' 6")

HX220 L HIGH WALKER WORKING RANGE

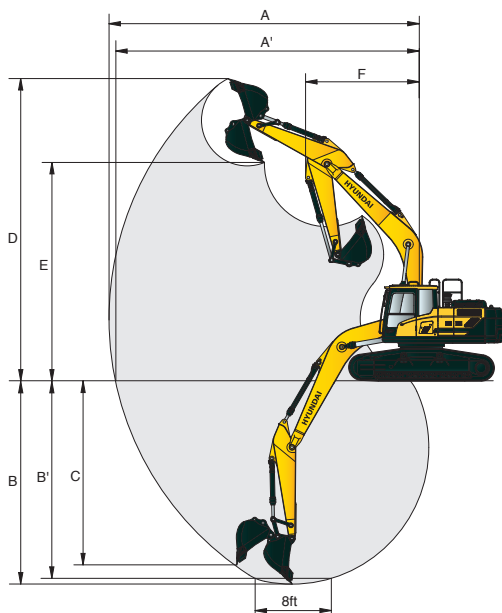

Unit : mm (ft-in)

Boom length		5,680 (18' 8")			
Arm length		2,000 (6' 7")	2,400 (7' 10")	2,920 (9' 7")	3,900 (12' 10")
A	Max. digging reach	9,140 (30' 0")	9,500 (31' 2")	9,980 (32' 9")	10,910 (35' 10")
A'	Max. digging reach on ground	8,920 (29' 3")	9,290 (30' 6")	9,820 (32' 3")	10,730 (35' 2")
B	Max. digging depth	5,630 (18' 6")	6,010 (19' 9")	6,550 (21' 6")	7,530 (24' 8")
B'	Max. digging depth (8° level)	5,390 (17' 8")	5,820 (19' 1")	6,380 (20' 11")	7,390 (24' 3")
C	Max. vertical wall digging depth	5,090 (16' 8")	5,630 (18' 6")	6,100 (20' 0")	7,050 (23' 1")
D	Max. digging height	9,330 (30' 7")	9,530 (31' 3")	9,780 (32' 1")	10,300 (33' 9")
E	Max. dumping height	6,520 (21' 5")	6,710 (22' 0")	6,960 (22' 10")	7,480 (24' 6")
F	Min. front swing radius	3,750 (12' 4")	3,740 (12' 3")	3,670 (12' 0")	3,700 (12' 2")

DIMENSIONS & WORKING RANGE

HX220 L/NL

HX220 NL DIMENSIONS

5.65 m (18' 6") BOOM and 2.0 m (6' 7"); 2.4 m (7' 10") & 2.92 m (9' 7") ARM

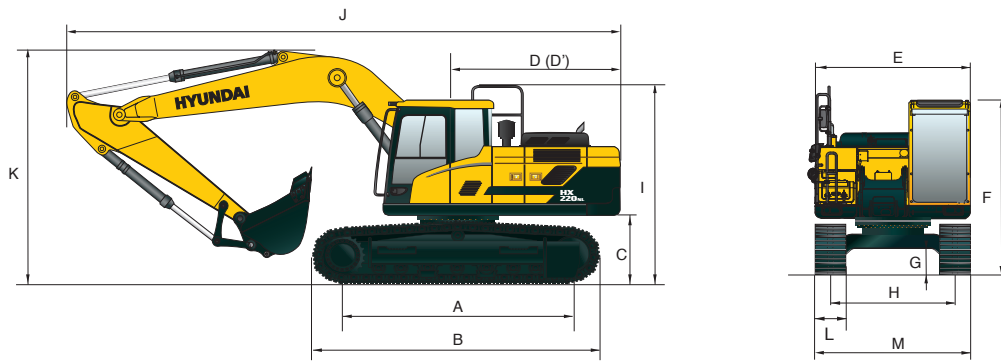

Unit : mm (ft-in)

A	Tumbler distance	3,650 (12' 0")
B	Overall length of crawler	4,404 (14' 4")
C	Ground clearance of counterweight	1,060 (3' 6")
D	Tail swing radius	2,850 (9' 4")
D'	Rear-end length	2,770 (9' 1")
E	Overall width of upperstructure	2,530 (8' 4")
F	Overall height of cab	3,000 (9' 8")
G	Min. ground clearance	480 (1' 7")
H	Track gauge	2,000 (6' 7")
I	Overall height of guardrail	3,210 (10' 5")

Boom length	5,650 (18' 6")		
Arm length	2,000 (6' 7")	2,400 (7' 10")	2,920 (9' 7")
J Overall length	9,650 (31' 8")	9,570 (31' 5")	9,510 (31' 23")
K Overall height of boom	3,250 (10' 8")	3,170 (10' 5")	3,100 (10' 2")
L Track shoe width	500 (20")	600 (24")	700 (28")
M Overall width	2,500 (8' 2")	2,600 (8' 6")	2,700 (8' 10")

HX220 NL WORKING RANGE

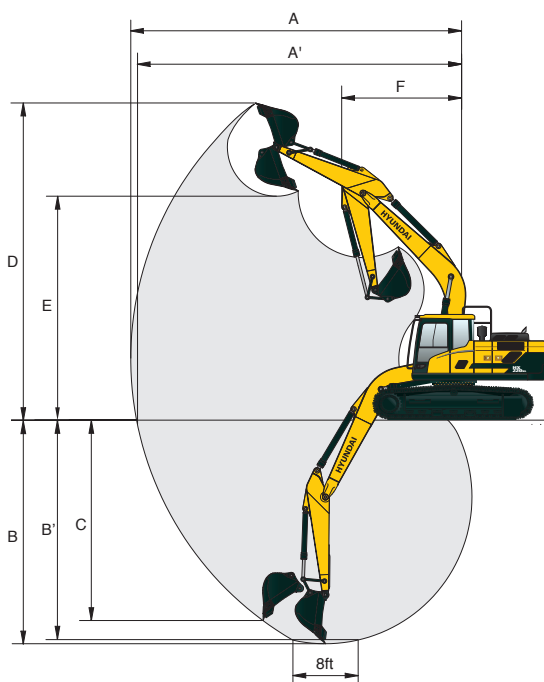

Unit : mm (ft-in)

Boom length	5,650 (18' 68")		
Arm length	2,000 (6' 7")	2,400 (7' 10")	2,920 (9' 7")
A Max. digging reach	9,140 (30' 0")	9,500 (31' 2")	9,960 (32' 8")
A' Max. digging reach on ground	8,960 (29' 5")	9,340 (30' 8")	9,800 (32' 2")
B Max. digging depth	5,750 (18' 10")	6,150 (20' 2")	6,640 (21' 9")
B' Max. digging depth (8° level)	5,520 (18' 1")	5,950 (19' 6")	6,470 (21' 36")
C Max. vertical wall digging depth	5,320 (17' 5")	5,780 (19' 9")	6,250 (20' 6")
D Max. digging height	9,270 (30' 5")	9,500 (31' 2")	9,740 (31' 11")
E Max. dumping height	6,450 (21' 2")	6,660 (21' 10")	6,900 (22' 8")
F Min. front swing radius	3,710 (12' 2")	3,630 (11' 11")	3,580 (11' 9")

DIMENSIONS & WORKING RANGE

HX220 L/NL

HX220 NL 2-PIECE BOOM DIMENSIONS

5.65 m (18' 6") 2-Piece BOOM and 2.0 m (6' 7"); 2.4 m (7' 10") & 2.92 m (9' 7") ARM

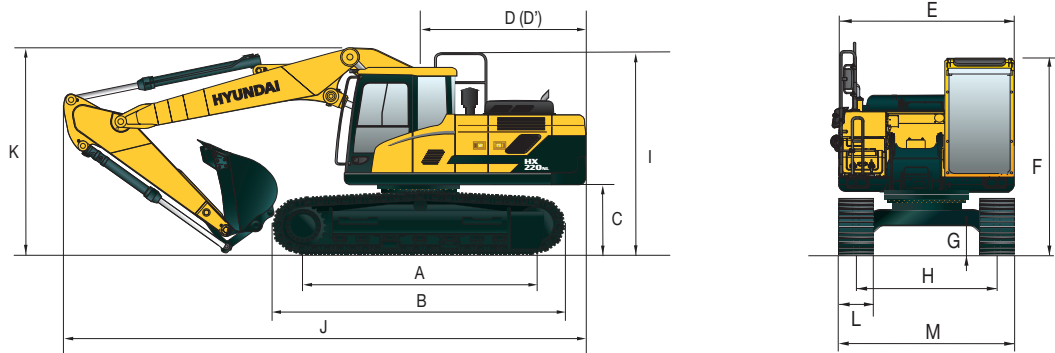

Unit : mm (ft-in)

A	Tumbler distance	3,650 (12' 0")
B	Overall length of crawler	4,404 (14' 4")
C	Ground clearance of counterweight	1,060 (3' 6")
D	Tail swing radius	2,850 (9' 4")
D'	Rear-end length	2,770 (9' 1")
E	Overall width of upperstructure	2,530 (8' 4")
F	Overall height of cab	3,000 (9' 8")
G	Min. ground clearance	480 (1' 7")
H	Track gauge	2,000 (6' 7")
I	Overall height of guardrail	3,210 (10' 5")

Boom length	5,650 (18' 6") 2-Piece Boom		
Arm length	2,000 (6' 7")	2,400 (7' 10")	2,920 (9' 7")
J Overall length	9,650 (31' 8")	9,570 (31' 5")	9,520 (31' 2")
K Overall height of boom	3,200 (10' 6")	3,000 (9' 10")	3,030 (9' 11")
L Track shoe width	500 (20")	600 (24")	700 (28")
M Overall width	2,500 (8' 2")	2,600 (8' 6")	2,700 (8' 10")

HX220 NL 2-PIECE BOOM WORKING RANGE

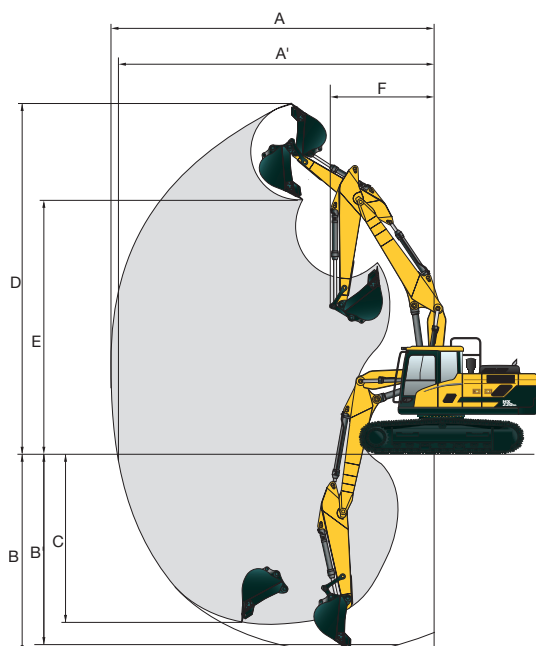

Unit : mm (ft-in)

Boom length	5,650 (18' 6") 2-Piece Boom		
Arm length	2,000 (6' 7")	2,400 (7' 10")	2,920 (9' 7")
A Max. digging reach	9,120 (29' 11")	9,530 (31' 3")	10,020 (32' 10")
A' Max. digging reach on ground	8,940 (29' 4")	9,360 (30' 9")	9,860 (32' 4")
B Max. digging depth	5,480 (18' 0")	5,890 (19' 4")	6,400 (21' 0")
B' Max. digging depth (8' level)	5,360 (17' 7")	5,770 (18' 11")	6,300 (20' 8")
C Max. vertical wall digging depth	4,560 (15' 0")	4,990 (16' 4")	5,530 (18' 2")
D Max. digging height	10,300 (33' 10")	10,670 (35' 0")	11,080 (36' 4")
E Max. dumping height	7,390 (24' 3")	7,740 (25' 5")	8,160 (26' 9")
F Min. front swing radius	2,870 (9' 5")	2,670 (8' 9")	2,530 (8' 4")











LIFTING CAPACITY

HX220 L / NL











 Rating over-front  Rating over-side or 360 degrees

HX220 L

5.68 m (18' 8") Boom; 2.00 m (6' 7") arm equipped with 0.92 m³ (SAE heaped) bucket and 600 mm (24") triple grouser shoes.

Load point height m (ft)	Load radius								At max. reach		
	3.0 m (10 ft)		4.5 m (15 ft)		6.0 m (20 ft)		7.5 m (25 ft)		Capacity		Reach m (ft)
											
7.5 m (25 ft)	kg								*3970	*3970	6.65
	lb								*8750	*8750	(21.8)
6.0 m (20 ft)	kg				*4400	*4400			*4020	3030	7.78
	lb				*9700	*9700			*8860	6680	(25.5)
4.5 m (15 ft)	kg		*5690	*5690	*4820	4640			*4140	2530	8.43
	lb		*12540	*12540	*10630	10230			*9130	5580	(27.7)
3.0 m (10 ft)	kg		*7420	6860	*5570	4370	*4780	3000	4050	2300	8.74
	lb		*16360	15120	*12280	9630	*10540	6610	8930	5070	(28.7)
1.5 m (5 ft)	kg		*8940	6340	*6340	4120	5080	2880	3990	2250	8.73
	lb		*19710	13980	*13980	9080	11200	6350	8800	4960	(28.6)
Ground Line	kg		*9640	6110	*6860	3960	4990	2810	4210	2370	8.42
	lb		*21250	13470	*15120	8730	11000	6190	9280	5220	(27.6)
-1.5 m (-5 ft)	kg	*13940	12320	*9580	6090	*6950	3910		4830	2750	7.76
	lb	*30730	27160	*21120	13430	*15320	8620		10650	6060	(25.5)
-3.0 m (-10 ft)	kg	*12450	*12450	*8770	6200	*6310	4000		*4800	3650	6.61
	lb	*27450	*27450	*19330	13670	*13910	8820		*10580	8050	(21.7)
-4.5 m (-15 ft)	kg	*9410	*9410								
	lb	*20750	*20750								

5.68 m (18' 8") Boom; 2.40 m (7' 10") arm equipped with 0.92 m³ (SAE heaped) bucket and 600 mm (24") triple grouser shoes.

Load point height m (ft)	Load radius								At max. reach				
	1.5 m (5 ft)		3.0 m (10 ft)		4.5 m (15 ft)		6.0 m (20 ft)		7.5 m (25 ft)		Capacity		Reach m (ft)
													
7.5 m (25 ft)	kg										*3660	3640	7.15
	lb										*8070	8020	(23.5)
6.0 m (20 ft)	kg						*3970	*3970			*3730	2750	8.20
	lb						*8750	*8750			*8220	6060	(26.9)
4.5 m (15 ft)	kg						*4450	*4450	*4190	3120	*3860	2320	8.82
	lb						*9810	*9810	*9240	6880	*8510	5110	(28.9)
3.0 m (10 ft)	kg				*6850	*6850	*5240	4410	*4520	3010	3760	2120	9.11
	lb				*15100	*15100	*11550	9720	*9960	6640	8290	4670	(29.9)
1.5 m (5 ft)	kg				*8510	6400	*6080	4130	*4930	2880	3710	2070	9.10
	lb				*18760	14110	*13400	9110	*10870	6350	8180	4560	(29.9)
Ground Line	kg		*8830	*8830	*9440	6100	*6700	3940	4960	2770	3890	2170	8.18
	lb		*19470	*19470	*20810	13450	*14770	8690	10930	6110	8580	4780	(26.8)
-1.5 m (-5 ft)	kg	*9800	*9800	*13550	12120	*9610	6020	*6920	3860		4400	2480	7.12
	lb	*21610	*21610	*29870	26720	*21190	13270	*15260	8510		9700	5470	(23.4)
-3.0 m (-10 ft)	kg	*14180	*14180	*13180	12340	*9040	6100	*6540	3900		*4660	3190	
	lb	*31260	*31260	*29060	27210	*19930	13450	*14420	8600		*10270	7030	
-4.5 m (-15 ft)	kg			*10580	*10580	*7350	6350						
	lb			*23320	*23320	*16200	14000						

1. Lifting capacity are based on SAE J1097 and ISO 10567.

2. Lifting capacity of the HX series does not exceed 75% of tipping load with the machine on firm, level ground or 87% of full hydraulic capacity.

3. The load point is a hook located on the back of the bucket.

4. (*) indicates load limited by hydraulic capacity.













LIFTING CAPACITY

HX220 L / NL















 Rating over-front  Rating over-side or 360 degrees

HX220 L

5.68 m (18' 8") Boom; 2.92 m (9' 7") arm equipped with 0.92 m³ (SAE heaped) bucket and 600 mm (24") triple grouser shoes.

Load point height m (ft)	Load radius										At max. reach			
	1.5 m (5 ft)		3.0 m (10 ft)		4.5 m (15 ft)		6.0 m (20 ft)		7.5 m (25 ft)		Capacity		Reach m (ft)	
														
7.5 m (25 ft)	kg											*3310	3140	7.78
	lb											*7300	6920	(25.5)
6.0 m (20 ft)	kg								*2300	*2300		*3400	2450	8.74
	lb								*5070	*5070		*7500	5400	(28.7)
4.5 m (15 ft)	kg							*3970	*3970	*3780	3170	*3530	2090	9.32
	lb							*8750	*8750	6990	6990	*7780	4610	(30.6)
3.0 m (10 ft)	kg			*9720	*9720	*6100	*6100	*4790	4460	*4180	3030	3440	1910	9.59
	lb			*21430	*21430	*13450	*13450	*10560	9830	*9220	6680	7580	4210	(31.5)
1.5 m (5 ft)	kg			*8850	*8850	*7900	6500	*5700	4150	*4660	2870	3380	1860	9.59
	lb			*19510	*19510	*17420	14330	*12570	9150	*10270	6330	7450	4100	(31.5)
Ground Line	kg			*9590	*9590	*9100	6100	*6440	3920	4930	2740	3520	1930	9.31
	lb			*21140	*21140	*20060	13450	*14200	8640	10870	6040	7760	4250	(30.5)
-1.5 m (-5 ft)	kg	*8840	*8840	*12650	11920	*9540	5940	*6810	3800	4860	2680	3910	2170	8.72
	lb	*19490	*19490	*27980	26280	*21030	13100	*15010	8380	10710	5910	8620	4780	(28.6)
-3.0 m (-10 ft)	kg	*12230	*12230	*13910	12080	*9260	5960	*6690	3800			*4420	2700	7.75
	lb	*26960	*26960	*30670	26630	*20410	13140	*14750	8380			*9740	5950	(25.4)
-4.5 m (-15 ft)	kg			*11800	*11800	*8060	6150					*4280	4080	6.16
	lb			*26010	*26010	*17770	13560					*9440	8990	(20.2)

5.68 m (18' 8") Boom; 3.90 m (12' 9") arm equipped with 0.92 m³ (SAE heaped) bucket and 600 mm (24") triple grouser shoes.

Load point height m (ft)	Load radius										At max. reach					
	1.5 m (5 ft)		3.0 m (10 ft)		4.5 m (15 ft)		6.0 m (20 ft)		7.5 m (25 ft)		9.0 m (30 ft)		Capacity		Reach m (ft)	
																
9.0 m (30 ft)	kg												*2700	*2700	7.66	
	lb												*5950	*5950	(25.1)	
7.5 m (25 ft)	kg								*1940	*1940				*2760	*2760	8.94
	lb								*4280	*4280				*6080	*6080	(29.3)
6.0 m (20 ft)	kg								*2790	*2790				*2850	2600	9.77
	lb								*6150	*6150				*6280	5730	(32.1)
4.5 m (15 ft)	kg								*3050	*3050	*2000	*2000	*2970	2300	10.28	
	lb								*6720	*6720	*4410	*4410	*6550	5070	(33.7)	
3.0 m (10 ft)	kg						*3900	*3900	*3510	*3510	*2870	2860	*3110	2140	10.52	
	lb						*8600	*8600	*7740	*7740	*6330	6310	*6860	4720	(34.5)	
1.5 m (5 ft)	kg			*11080	*11080	*6600	*6600	*4900	*4900	*4080	3820	*3410	2760	3080	2090	10.52
	lb			*24430	*24430	*14550	*14550	*10800	*10800	*8990	8420	*7520	6080	6790	4610	(34.5)
Ground Line	kg	*5300	*5300	*10640	*10640	*8200	*8200	*5820	5210	*4610	3630	*3490	2660	3180	2150	10.27
	lb	*11680	*11680	*23460	*23460	*18080	*18080	*12830	11490	*10160	8000	*7690	5860	7010	4740	(33.7)
-1.5 m (-5 ft)	kg	*7540	*7540	*11690	*11690	*9110	7900	*6440	4990	*4990	3510	*2330	*2330	3450	2340	9.75
	lb	*16620	*16620	*25770	*25770	*20080	17420	*14200	11000	*11000	7740	*5140	*5140	7610	5160	(32.0)
-3.0 m (-10 ft)	kg	*10030	*10030	*14390	*14390	*9320	7800	*6660	4910	*5070	3470			*3850	2750	8.91
	lb	*22110	*22110	*31720	*31720	*20550	17200	*14680	10820	*11180	7650			*8490	6060	(29.2)
-4.5 m (-15 ft)	kg	*13000	*13000	*13310	*13310	*8780	7890	*6290	4960					*3990	3640	7.62
	lb	*28660	*28660	*29340	*29340	*19360	17390	*13870	10930					*8800	8020	(25.0)
-6.0 m (-20 ft)	kg			*10560	*10560	*7050	*7050									
	lb			*23280	*23280	*15540	*15540									

- Lifting capacity are based on SAE J1097 and ISO 10567.
- Lifting capacity of the HX series does not exceed 75% of tipping load with the machine on firm, level ground or 87% of full hydraulic capacity.

- The load point is a hook located on the back of the bucket.
- (*) indicates load limited by hydraulic capacity.











LIFTING CAPACITY

HX220 L / NL











 Rating over-front  Rating over-side or 360 degrees

HX220 L 2-PIECE BOOM

5.65 m (18' 6") 2-Piece Boom; 2.00 m (6' 7") arm equipped with 0.92 m³ (SAE heaped) bucket and 600 mm (24") triple grouser shoes.

Load point height m (ft)	Load radius								At max. reach			
	3.0 m (10 ft)		4.5 m (15 ft)		6.0 m (20 ft)		7.5 m (25 ft)		Capacity		Reach m (ft)	
												
10.5 m (35 ft)	kg									*6180	*6180	4.64 (15.2)
9.0 m (30 ft)	kg									*13620	*13620	4.61 (15.1)
7.5 m (25 ft)	kg			*6710	*6710					*5270	4060	6.67 (21.9)
6.0 m (20 ft)	kg			*14790	*14790					*11620	8950	7.80 (25.6)
4.5 m (15 ft)	kg			6780	*6870	*5850	4780			*4850	2970	8.45 (27.7)
3.0 m (10 ft)	kg			15150	*15150	*12900	10540			*10690	6550	8.75 (28.7)
1.5 m (5 ft)	kg	*11340	*11340	*7750	7500	*6130	4610			4360	2470	8.75 (28.7)
Ground Line	kg	*25000	*25000	*17090	16530	*13510	10160			9610	5450	8.44 (27.7)
-1.5 m (-5 ft)	kg			*8930	6810	*6590	4330	5200	2950	4030	2250	7.77 (25.5)
-3.0 m (-10 ft)	kg			*19690	15010	*14530	9550	11460	6500	8880	4960	8.44 (27.7)
	lb			*21160	13780	*15210	8950	11180	6240	8770	4850	8.44 (27.7)
	lb	*9840	*9840	*8130	6010	*6060	3850			*3360	2710	8.44 (27.7)
	lb	*21690	*21690	*17920	13250	*13360	8490			*7410	5970	8.44 (27.7)
	kg			*6030	*6030	*4250	3970					
	lb			*13290	*13290	*9370	8750					

5.65 m (18' 6") 2-Piece Boom; 2.40 m (7' 10") arm equipped with 0.92 m³ (SAE heaped) bucket and 600 mm (24") triple grouser shoes.

Load point height m (ft)	Load radius								At max. reach			
	3.0 m (10 ft)		4.5 m (15 ft)		6.0 m (20 ft)		7.5 m (25 ft)		Capacity		Reach m (ft)	
												
9.0 m (30 ft)	kg									*5690	*5690	5.40 (17.7)
7.5 m (25 ft)	kg			*5860	*5860					*12540	*12540	7.19 (23.6)
6.0 m (20 ft)	kg			*12920	*12920					*4850	3560	8.23 (27.0)
4.5 m (15 ft)	kg			*6410	*6410	*5520	4860			*9940	5930	8.85 (29.0)
3.0 m (10 ft)	kg			*14130	*14130	*12170	10710			4020	2260	9.14 (30.0)
1.5 m (5 ft)	kg	*10290	*10290	*7300	*7300	*5860	4670	*4360	3080	8860	4980	9.13 (30.0)
Ground Line	kg	*22690	*22690	*16090	*16090	*12920	10300	*9610	6790	8250	4540	8.84 (29.0)
-1.5 m (-5 ft)	kg			*8550	6940	*6370	4370	*5170	2960	3740	2060	8.21 (26.9)
-3.0 m (-10 ft)	kg			*18850	15300	*14040	9630	*11140	6530	8250	4540	8.21 (26.9)
	kg			*9440	6320	*6780	4070	5070	2820	3690	2020	8.21 (26.9)
	lb			*20810	13930	*14950	8970	11180	6220	8140	4450	8.21 (26.9)
	kg	*8600	*8600	*9420	6000	*6820	3870	4960	2720	*3760	2120	8.21 (26.9)
	lb	*18960	*18960	*20770	13230	*15040	8530	10930	6000	*8290	4670	8.21 (26.9)
	kg	*11240	*11240	*8510	5930	*6280	3800	*4460	2710	*3310	2440	8.21 (26.9)
	lb	*24780	*24780	*18760	13070	*13850	8380	*9830	5970	*7300	5380	8.21 (26.9)
	kg			*6700	6040	*4870	3860					
	lb			*14770	13320	*10740	8510					

- Lifting capacity are based on SAE J1097 and ISO 10567.
- Lifting capacity of the HX series does not exceed 75% of tipping load with the machine on firm, level ground or 87% of full hydraulic capacity.
- The load point is a hook located on the back of the bucket.
- (*.) indicates load limited by hydraulic capacity.











LIFTING CAPACITY

HX220 L / NL

 Rating over-front  Rating over-side or 360 degrees

HX220 L 2-PIECE BOOM

5.65 m (18' 6") 2-Piece Boom; 2.92 m (9' 7") arm equipped with 0.92 m³ (SAE heaped) bucket and 600 mm (24") triple grouser shoes.

Load point height m (ft)	Load radius								At max. reach			
	3.0 m (10 ft)		4.5 m (15 ft)		6.0 m (20 ft)		7.5 m (25 ft)		Capacity		Reach m (ft)	
												
9.0 m (30 ft)	kg		*3290	*3290					*4590	*4590	6.28	
	lb		*7250	*7250					*10120	*10120	(20.6)	
7.5 m (25 ft)	kg				*3520	*3520			*4020	3060	7.83	
	lb				*7760	*7760			*8860	6750	(25.7)	
6.0 m (20 ft)	kg		*5160	*5160	*4870	*4870	*2440	*2440	*3790	2370	8.79	
	lb		*11380	*11380	*10740	*10740	*5380	*5380	*8360	5220	(28.8)	
4.5 m (15 ft)	kg		*6680	*6680	*5480	4750	*4380	3140	3650	2020	9.36	
	lb		*14730	*14730	*12080	10470	*9660	6920	8050	4450	(30.7)	
3.0 m (10 ft)	kg	*12620	*12620	*8000	7130	*6060	4430	*4970	2990	3400	1850	9.63
	lb	*27820	*27820	*17640	15720	*13360	9770	*10960	6590	7500	4080	(31.6)
1.5 m (5 ft)	kg	*8680	*8680	*9130	6430	*6580	4100	5070	2820	3350	1800	9.63
	lb	*19140	*19140	*20130	14180	*14510	9040	11180	6220	7390	3970	(31.6)
Ground Line	kg	*9390	*9390	*9450	6000	*6780	3850	4930	2690	3500	1880	9.35
	lb	*20700	*20700	*20830	13230	*14950	8490	10870	5930	7720	4140	(30.7)
-1.5 m (-5 ft)	kg	*12500	11770	*8880	5850	*6460	3730	*4770	2630	*3200	2130	8.77
	lb	*27560	25950	*19580	12900	*14240	8220	*10520	5800	*7050	4700	(28.8)
-3.0 m (-10 ft)	kg	*9950	*9950	*7420	5890	*5420	3750					
	lb	*21940	*21940	*16360	12990	*11950	8270					

1. Lifting capacity are based on SAE J1097 and ISO 10567.

2. Lifting capacity of the HX series does not exceed 75% of tipping load with the machine on firm, level ground or 87% of full hydraulic capacity.

3. The load point is a hook located on the back of the bucket.

4. (*) indicates load limited by hydraulic capacity.

















LIFTING CAPACITY

HX220 L/NL

 Rating over-front  Rating over-side or 360 degrees

HX220 L LONG REACH

8.2 m (26' 11") Boom; 6.3 m (20' 8") arm equipped with 0.52 m³ (SAE heaped) bucket and 800 mm (32") triple grouser shoes.

Load point height m (ft)	Load radius										At max. reach								
	4.5 m (15 ft)		6.0 m (20 ft)		7.5 m (25 ft)		9.0 m (30 ft)		10.5 m (35 ft)		12.0 m (40 ft)		13.5 m (45 ft)		Capacity	Reach			
																	m (ft)		
10.5 m (35 ft)	kg																*1470	*1470	12.11
	lb																*3240	*3240	(39.7)
9.0 m (30 ft)	kg											*930	*930				*1490	*1490	13.11
	lb											*2050	*2050				*3280	*3280	(43.0)
7.5 m (25 ft)	kg											*1540	*1540				*1530	1350	13.84
	lb											*3400	*3400				*3370	2980	(45.4)
6.0 m (20 ft)	kg									*1590	*1590	*1600	*1600				*1580	1190	14.37
	lb									*3510	*3510	*3530	*3530				*3480	2620	(47.1)
4.5 m (15 ft)	kg									*1770	*1770	*1710	*1710	*1260	*1260		*1630	1080	14.72
	lb									*3900	*3900	*3770	*3770	*2780	*2780		*3590	2380	(48.3)
3.0 m (10 ft)	kg				*2500	*2500	*2200	*2200	*2000	*2000	*1860	1670	*1590	1260			*1700	1010	14.89
	lb				*5510	*5510	*4850	*4850	*4410	*4410	*4100	3680	*3510	2780			*3750	2230	(48.9)
1.5 m (5 ft)	kg	*5570	*5570	*3900	*3900	*3060	*3060	*2560	*2560	*2240	2050	*2030	1570	*1790	1200		*1780	970	14.90
	lb	*12280	*12280	*8600	*8600	*6750	*6750	*5640	*5640	*4940	4520	*4480	3460	*3950	2650		*3920	2140	(48.9)
Ground Line	kg	*6930	6870	*4720	4590	*3580	3320	*2910	2490	*2490	1910	*2200	1480	*1820	1140		*1860	960	14.75
	lb	*15280	15150	*10410	10120	*7890	7320	*6420	5490	*5490	4210	*4850	3260	*4010	2510		*4100	2120	(48.4)
-1.5 m (-5 ft)	kg	*7750	6340	*5330	4220	*4020	3060	*3220	2320	*2700	1790	*2350	1400	*1570	1100		*1960	990	14.42
	lb	*17090	13980	*11750	9300	*8860	6750	*7100	5110	*5950	3950	*5180	3090	*3460	2430		*4320	2180	(47.3)
-3.0 m (-10 ft)	kg	*8150	6120	*5720	4000	*4330	2890	*3450	2190	*2870	1700	*2460	1340				*2060	1050	13.92
	lb	*17970	13490	*12610	8820	*9550	6370	*7610	4830	*6330	3750	*5420	2950				*4540	2310	(45.7)
-4.5 m (-15 ft)	kg	*8220	6060	*5890	3910	*4490	2810	*3590	2120	*2960	1660	*2490	1330				*2180	1170	13.20
	lb	*18120	13360	*12990	8620	*9900	6190	*7910	4670	*6530	3660	*5490	2930				*4810	2580	(43.3)
-6.0 m (-20 ft)	kg	*8020	6130	*5840	3920	*4500	2790	*3600	2110	*2940	1660						*2310	1370	12.25
	lb	*17680	13510	*12870	8640	*9920	6150	*7940	4650	*6480	3660						*5090	3020	(40.2)
-7.5 m (-25 ft)	kg	*7500	6310	*5550	4010	*4300	2850	*3420	2170	*2700	1730						*2430	1710	10.97
	lb	*16530	13910	*12240	8840	*9480	6280	*7540	4780	*5950	3810						*5360	3770	(36.0)
-9.0 m (-30 ft)	kg	*6570	*6570	*4920	4200	*3790	3000	*2890	2320										
	lb	*14480	*14480	*10850	9260	*8360	6610	*6370	5110										
-10.5 m (-35 ft)	kg	*4970	*4970	*3680	*3680														
	lb	*10960	*10960	*8110	*8110														

1. Lifting capacity are based on SAE J1097 and ISO 10567.

2. Lifting capacity of the HX series does not exceed 75% of tipping load with the machine on firm, level ground or 87% of full hydraulic capacity.

3. The load point is a hook located on the back of the bucket.

4. (*) indicates load limited by hydraulic capacity.











LIFTING CAPACITY

HX220 L/NL











 Rating over-front  Rating over-side or 360 degrees

HX220 L HIGH WALKER

5.68 m (18' 8") Boom; 2.00 m (6' 7") arm equipped with 0.92 m³ (SAE heaped) bucket and 600 mm (24") triple grouser shoes.

Load point height m (ft)	Load radius								At max. reach		
	3.0 m (10 ft)		4.5 m (15 ft)		6.0 m (20 ft)		7.5 m (25 ft)		Capacity		Reach m (ft)
											
7.5 m (25 ft)	kg								*3970	*3970	6.65
	lb								*8750	*8750	(21.8)
6.0 m (20 ft)	kg				*4400	*4400			*4020	3920	7.78
	lb				*9700	*9700			*8860	8640	(25.5)
4.5 m (15 ft)	kg		*5690	*5690	*4820	*4820			*4140	3330	8.43
	lb		*12540	*12540	*10630	*10630			*9130	7340	(27.7)
3.0 m (10 ft)	kg		*7420	*7420	*5570	*5570	*4780	3930	*4300	3060	8.74
	lb		*16360	*16360	*12280	*12280	*10540	8660	*9480	6750	(28.7)
1.5 m (5 ft)	kg		*8940	8430	*6340	5420	*5140	3810	4300	3010	8.73
	lb		*19710	18580	*13980	11950	*11330	8400	9480	6640	(28.6)
Ground Line	kg		*9640	8190	*6860	5250	*5370	3730	4540	3170	8.42
	lb		*21250	18060	*15120	11570	*11840	8220	10010	6990	(27.6)
-1.5 m (-5 ft)	kg	*13940	*13940	*9580	8160	*6950	5190		*4840	3630	7.76
	lb	*30730	*30730	*21120	17990	*15320	11440		*10670	8000	(25.5)
-3.0 m (-10 ft)	kg	*12450	*12450	*8770	8290	*6310	5290		*4800	4780	6.61
	lb	*27450	*27450	*19330	18280	*13910	11660		*10580	10540	(21.7)
-4.5 m (-15 ft)	kg	*9410	*9410								
	lb	*20750	*20750								

5.68 m (18' 8") Boom; 2.40 m (7' 10") arm equipped with 0.92 m³ (SAE heaped) bucket and 600 mm (24") triple grouser shoes.

Load point height m (ft)	Load radius								At max. reach				
	1.5 m (5 ft)		3.0 m (10 ft)		4.5 m (15 ft)		6.0 m (20 ft)		7.5 m (25 ft)		Capacity		Reach m (ft)
													
7.5 m (25 ft)	kg										*3660	*3660	7.15
	lb										*8070	*8070	(23.5)
6.0 m (20 ft)	kg						*3970	*3970			*3730	3580	8.20
	lb						*8750	*8750			*8220	7890	(26.9)
4.5 m (15 ft)	kg						*4450	*4450	*4190	4060	*3860	3070	8.82
	lb						*9810	*9810	*9240	8950	*8510	6770	(28.9)
3.0 m (10 ft)	kg				*6850	*6850	*5240	*5240	*4520	3940	*4020	2840	9.11
	lb				*15100	*15100	*11550	*11550	*9960	8690	*8860	6260	(29.9)
1.5 m (5 ft)	kg				*8510	8500	*6080	5430	*4930	3810	4010	2780	9.10
	lb				*18760	18740	*13400	11970	*10870	8400	8840	6130	(29.9)
Ground Line	kg		*8830	*8830	*9440	8180	*6700	5230	*5250	3700	4200	2920	8.81
	lb		*19470	*19470	*20810	18030	*14770	11530	*11570	8160	9260	6440	(28.9)
-1.5 m (-5 ft)	kg	*9800	*9800	*13550	*13550	*9610	8090	*6920	5140		*4590	3300	8.18
	lb	*21610	*21610	*29870	*29870	*21190	17840	*15260	11330		*10120	7280	(26.8)
-3.0 m (-10 ft)	kg	*14180	*14180	*13180	*13180	*9040	8170	*6540	5190		*4660	4190	7.12
	lb	*31260	*31260	*29060	*29060	*19930	18010	*14420	11440		*10270	9240	(23.4)
-4.5 m (-15 ft)	kg			*10580	*10580	*7350	*7350						
	lb			*23320	*23320	*16200	*16200						

1. Lifting capacity are based on SAE J1097 and ISO 10567.

2. Lifting capacity of the HX series does not exceed 75% of tipping load with the machine on firm, level ground or 87% of full hydraulic capacity.













3. The load point is a hook located on the back of the bucket.

4. (*) indicates load limited by hydraulic capacity.















 Rating over-front  Rating over-side or 360 degrees

HX220 L HIGH WALKER

5.68 m (18' 8") Boom; 2.92 m (9' 7") arm equipped with 0.92 m³ (SAE heaped) bucket and 600 mm (24") triple grouser shoes.

Load point height m (ft)	Load radius										At max. reach			
	1.5 m (5 ft)		3.0 m (10 ft)		4.5 m (15 ft)		6.0 m (20 ft)		7.5 m (25 ft)		Capacity		Reach m (ft)	
														
7.5 m (25 ft)	kg											*3310	*3310	7.78
	lb											*7300	*7300	(25.5)
6.0 m (20 ft)	kg								*2300	*2300		*3400	*3210	8.74
	lb								*5070	*5070		*7500	*7080	(28.7)
4.5 m (15 ft)	kg							*3970	*3970	*3780	*3780	*3530	2780	9.32
	lb							*8750	*8750	*8330	*8330	*7780	6130	(30.6)
3.0 m (10 ft)	kg		*9720	*9720	*6100	*6100	*4790	*4790	*4180	3970		*3680	2580	9.59
	lb		*21430	*21430	*13450	*13450	*10560	*10560	*9220	8750		*8110	5690	(31.5)
1.5 m (5 ft)	kg		*8850	*8850	*7900	*7900	*5700	5450	*4660	3800		3660	2530	9.59
	lb		*19510	*19510	*17420	*17420	*12570	12020	*10270	8380		8070	5580	(31.5)
Ground Line	kg		*9590	*9590	*9100	8180	*6440	5210	*5060	3670		3810	2630	9.31
	lb		*21140	*21140	*20060	18030	*14200	11490	*11160	8090		8400	5800	(30.5)
-1.5 m (-5 ft)	kg	*8840	*8840	*12650	*12650	*9540	8010	*6810	5080	5240	3610	4230	2930	8.72
	lb	*19490	*19490	*27890	*27890	*21030	17660	*15010	11200	11550	7960	9330	6460	(28.6)
-3.0 m (-10 ft)	kg	*12230	*12230	*13910	*13910	*9260	8040	*6690	5080			*4420	3590	7.75
	lb	*26960	*26960	*30670	*30670	*20410	17730	*14750	11200			*9740	7910	(25.4)
-4.5 m (-15 ft)	kg		*11800	*11800	*8060	*8060						*4280	*4280	6.16
	lb		*26010	*26010	*17770	*17770						*9440	*9440	(20.2)

5.68 m (18' 8") Boom; 3.90 m (12' 9") arm equipped with 0.92 m³ (SAE heaped) bucket and 600 mm (24") triple grouser shoes.

Load point height m (ft)	Load radius										At max. reach					
	1.5 m (5 ft)		3.0 m (10 ft)		4.5 m (15 ft)		6.0 m (20 ft)		7.5 m (25 ft)		9.0 m (30 ft)		Capacity		Reach m (ft)	
																
9.0 m (30 ft)	kg													*2700	*2700	7.66
	lb													*5950	*5950	(25.1)
7.5 m (25 ft)	kg								*1940	*1940				*2760	*2760	8.94
	lb								*4280	*4280				*6080	*6080	29.3
6.0 m (20 ft)	kg								*2790	*2790				*2850	2600	9.77
	lb								*6150	*6150				*6280	5730	(32.1)
4.5 m (15 ft)	kg								*3050	*3050	*2000	*2000		*2970	2300	10.28
	lb								*6720	*6720	*4410	*4410		*6550	5070	(33.7)
3.0 m (10 ft)	kg						*3900	*3900	*3510	*3510	*2870	2860		*3110	2140	10.52
	lb						*8600	*8600	*7740	*7740	*6330	6310		*6860	4720	(34.5)
1.5 m (5 ft)	kg		*11080	*11080	*6600	*6600	*4900	*4900	*4080	3820	*3410	2760		3080	2090	10.52
	lb		*24430	*24430	*14550	*14550	*10800	*10800	*8990	8420	*7520	6080		6790	4610	(34.5)
Ground Line	kg	*5300	*5300	*10640	*10640	*8200	*8200	*5820	5210	*4610	3630	*3490	2660	3180	2150	10.27
	lb	*11680	*11680	*23460	*23460	*18080	*18080	*12830	11490	*10160	8000	*7690	5860	7010	4740	(33.7)
-1.5 m (-5 ft)	kg	*7540	*7540	*11690	*11690	*9110	7900	*6440	4990	*4990	3510	*2330	*2330	3450	2340	9.75
	lb	*16620	*16620	*25770	*25770	*20080	17420	*14200	11000	*11000	7740	*5140	*5140	7610	5160	(32.0)
-3.0 m (-10 ft)	kg	*10030	*10030	*14390	*14390	*9320	7800	*6660	4910	*5070	3470			*3850	2750	8.91
	lb	*22110	*22110	*31720	*31720	*20550	17200	*14680	10820	*11180	7650			*8490	6060	29.2
-4.5 m (-15 ft)	kg	*13000	*13000	*13310	*13310	*8780	7890	*6290	4960					*3990	3640	7.62
	lb	*28660	*28660	*29340	*29340	*19360	17390	*13870	10930					*8800	8020	(25.0)
-6.0 m (-20 ft)	kg		*10560	*10560	*7050	*7050										
	lb		*23280	*23280	*15540	*15540										

- Lifting capacity are based on SAE J1097 and ISO 10567.
- Lifting capacity of the HX series does not exceed 75% of tipping load with the machine on firm, level ground or 87% of full hydraulic capacity.
- The load point is a hook located on the back of the bucket.
- (*) indicates load limited by hydraulic capacity.











LIFTING CAPACITY

HX220 L/NL











 Rating over-front  Rating over-side or 360 degrees

HX220 NL

5.65 m (18' 6") Boom; 2.00 m (6' 7") arm equipped with 0.87 m³ (SAE heaped) bucket and 500 mm (20") triple grouser shoes.

Load point height m (ft)	Load radius								At max. reach		
	3.0 m (10 ft)		4.5 m (15 ft)		6.0 m (20 ft)		7.5 m (25 ft)		Capacity		Reach m (ft)
											
7.5 m (25 ft)	kg								*4000	3810	6.61 (21.7)
	lb								*8820	8400	
6.0 m (20 ft)	kg				*4420	4380			*4060	2800	7.75 (25.4)
	lb				*9740	9660			*8950	6170	
4.5 m (15 ft)	kg		*5670	*5670	*4840	4230			*4200	2340	8.41 (27.6)
	lb		*12500	*12500	*10670	9330			*9260	5160	
3.0 m (10 ft)	kg		*7430	6170	*5600	3990	*4830	2750	*4360	2130	8.71 (28.6)
	lb		*16380	13600	*12350	8800	*10650	6060	*9610	4700	
1.5 m (5 ft)	kg		*8990	5700	*6390	3760	*5190	2640	4330	2080	8.71 (28.6)
	lb		*19820	12570	*14090	8290	*11440	5820	9550	4590	
Ground Line	kg		*9720	5490	*6930	3610	5380	2570	4570	2190	8.40 (27.6)
	lb		*21430	12100	*15280	7960	11860	5670	10080	4830	
-1.5 m (-5 ft)	kg	*14170	10580	*9690	5460	*7030	3560		*4930	2540	7.73 (25.4)
	lb	*31240	23320	*21360	12040	*15500	7850		*10870	5600	
-3.0 m (-10 ft)	kg	*12680	10790	*8900	5570	*6390	3650		*4910	3380	6.58 (21.6)
	lb	*27950	23790	*19620	12280	*14090	8050		*10820	7450	

5.65 m (18' 6") Boom; 2.00 m (6' 7") arm equipped with 0.87 m³ (SAE heaped) bucket and 500 mm (20") triple grouser shoes.

Load point height m (ft)	Load radius								At max. reach				
	1.5 m (5 ft)		3.0 m (10 ft)		4.5 m (15 ft)		6.0 m (20 ft)		7.5 m (25 ft)		Capacity		Reach m (ft)
													
7.5 m (25 ft)	kg										*3690	3360	7.12 (23.4)
	lb										*8140	7410	
6.0 m (20 ft)	kg						*3990	*3990			*3780	2540	8.18 (26.8)
	lb						*8800	*8800			*8330	5600	
4.5 m (15 ft)	kg						*4460	4280	*4050	2860	*3910	2140	8.80 (28.9)
	lb						*9830	9440	*8930	6310	*8620	4720	
3.0 m (10 ft)	kg				*6850	6280	*5260	4020	*4560	2760	*4080	1950	9.09 (29.8)
	lb				*15100	13850	*11600	8860	*10050	6080	*8990	4300	
1.5 m (5 ft)	kg				*8540	5750	*6120	3760	*4980	2630	4030	1910	9.08 (29.8)
	lb				*18830	12680	*13490	8290	*10980	5800	8880	4210	
Ground Line	kg		*9080	*9080	*9520	5470	*6760	3580	*5310	2540	4220	2000	8.79 (28.8)
	lb		*20020	*20020	*20990	12060	*14900	7890	*11710	5600	9300	4410	
-1.5 m (-5 ft)	kg	*9930	*9930	*13780	10400	*9710	5400	*6990	3510		*4670	2280	8.16 (26.8)
	lb	*21890	*21890	*30380	22930	*21410	11900	*15410	7740		*10300	5030	
-3.0 m (-10 ft)	kg	*14320	*14320	*13400	10600	*9170	5470	*6630	3550		*4750	2940	7.09 (23.3)
	lb	*31570	*31570	*29540	23370	*20220	12060	*14620	7830		*10470	6480	
-4.5 m (-15 ft)	kg			*10790	*10790	*7470	5710						
	lb			*23790	*23790	*16470	12590						

1. Lifting capacity are based on SAE J1097 and ISO 10567.

2. Lifting capacity of the HX series does not exceed 75% of tipping load with the machine on firm, level ground or 87% of full hydraulic capacity.

3. The load point is a hook located on the back of the bucket.

4. (*) indicates load limited by hydraulic capacity.













LIFTING CAPACITY

HX220 L / NL

 Rating over-front  Rating over-side or 360 degrees











HX220 NL

5.65 m (18' 6") Boom; 2.92 m (9' 7") arm equipped with 0.87 m³ (SAE heaped) bucket and 500 mm (20") triple grouser shoes.

Load point height m (ft)	Load radius										At max. reach			
	1.5 m (5 ft)		3.0 m (10 ft)		4.5 m (15 ft)		6.0 m (20 ft)		7.5 m (25 ft)		Capacity		Reach m (ft)	
														
7.5 m (25 ft)	kg											*3350	2890	7.76
	lb											*7390	6370	(25.5)
6.0 m (20 ft)	kg								*2140	*2140		*3440	2250	8.73
	lb								*4720	*4720		*7580	4960	(28.6)
4.5 m (15 ft)	kg						*3970	*3970	*3810	2900		*3580	1920	9.30
	lb						*8750	*8750	*8400	6390		*7890	4230	(30.5)
3.0 m (10 ft)	kg		*9630	*9630	*6090	*6090	*4810	4060	*4210	2770		3730	1750	9.58
	lb		*21230	*21230	*13430	*13430	*10600	8950	*9280	6110		8220	3860	(31.4)
1.5 m (5 ft)	kg		*9210	*9210	*7920	5830	*5730	3780	*4700	2630		3680	1710	9.57
	lb		*20300	*20300	*17460	12850	*12630	8330	*10360	5800		8110	3770	(31.4)
Ground Line	kg		*9810	*9810	*9160	5460	*6490	3560	*5120	2510		3830	1780	9.29
	lb		*21630	*21630	*20190	12040	*14310	7850	*11290	5530		8440	3920	(30.5)
-1.5 m (-5 ft)	kg	*8950	*8950	*12850	10220	*9630	5320	*6880	3450	5250	2450	4250	2000	8.71
	lb	*19730	*19730	*28330	22530	*21230	11730	*15170	7610	11570	5400	9370	4410	(28.6)
-3.0 m (-10 ft)	kg	*12340	*12340	*14120	10360	*9380	5340	*6770	3450			*4490	2490	7.73
	lb	*27210	*27210	*31130	22840	*20680	11770	*14930	7610			*9900	5490	(25.4)
-4.5 m (-15 ft)	kg		*12010	10690	*8180	5510						*4360	3750	6.14
	lb		*26480	23570	*18030	12150						*9610	8270	(20.1)

HX220 NL 2-PIECE BOOM

5.65 m (18' 6") 2-Piece Boom; 2.00 m (6' 7") arm equipped with 0.87 m³ (SAE heaped) bucket and 500 mm (20") triple grouser shoes.

Load point height m (ft)	Load radius								At max. reach			
	3.0 m (10 ft)		4.5 m (15 ft)		6.0 m (20 ft)		7.5 m (25 ft)		Capacity		Reach m (ft)	
												
10.5 m (35 ft)	kg									*6200	*6200	4.64
	lb									*13670	*13670	(15.2)
9.0 m (30 ft)	kg									*6560	*6560	4.60
	lb									*14460	*14460	(15.1)
7.5 m (25 ft)	kg		*6750	*6750						*5330	3710	6.66
	lb		*14880	*14880						*11750	8180	(21.9)
6.0 m (20 ft)	kg		*6910	*6910	*5910	4340				*4920	2720	7.79
	lb		*15230	*15230	*13030	9570				*10850	6000	(25.6)
4.5 m (15 ft)	kg	*11400	*11400	*7810	6710	*6200	4190			4680	2270	8.45
	lb	*25130	*25130	*17220	14790	*13670	9240			10320	5000	(27.7)
3.0 m (10 ft)	kg		*9020	6090	*6670	3930	*5380	2700		4350	2060	8.75
	lb		*19890	13430	*14700	8660	*11860	5950		9590	4540	(28.7)
1.5 m (5 ft)	kg		*9720	5600	*6990	3690	*5410	2590		4300	2020	8.75
	lb		*21430	12350	*15410	8140	*11930	5710		9480	4450	(28.7)
Ground Line	kg		*9430	5390	*6900	3540	*5130	2520		*4020	2140	8.43
	lb		*20790	11880	*15210	7800	*11310	5560		*8860	4720	(27.7)
-1.5 m (-5 ft)	kg	*10050	*10050	*8270	5380	*6170	3500			*3440	2490	7.77
	lb	*22160	*22160	*18230	11860	*13600	7720			*7580	5490	(25.5)
-3.0 m (-10 ft)	kg		*6160	5520	*4350	3610						
	lb		*13580	12170	*9590	7960						

- Lifting capacity are based on SAE J1097 and ISO 10567.
- Lifting capacity of the HX series does not exceed 75% of tipping load with the machine on firm, level ground or 87% of full hydraulic capacity.
- The load point is a hook located on the back of the bucket.
- (*) indicates load limited by hydraulic capacity.











LIFTING CAPACITY

HX220 L/NL











 Rating over-front  Rating over-side or 360 degrees

HX220 NL 2-PIECE BOOM

5.65 m (18' 6") 2-Piece Boom; 2.40 m (7' 10") arm equipped with 0.87 m³ (SAE heaped) bucket and 500 mm (20") triple grouser shoes.

Load point height m (ft)	Load radius								At max. reach			
	3.0 m (10 ft)		4.5 m (15 ft)		6.0 m (20 ft)		7.5 m (25 ft)		Capacity		Reach m (ft)	
												
9.0 m (30 ft)	kg								*5730	5470	5.39	
	lb								*12630	12060	(17.7)	
7.5 m (25 ft)	kg		*5870	*5870					*4900	3260	7.18	
	lb		*12940	*12940					*10800	7190	(23.6)	
6.0 m (20 ft)	kg		*6440	*6440	*5570	4420			*4570	2460	8.23	
	lb		*14200	*14200	*12280	9740			*10080	5420	(27.0)	
4.5 m (15 ft)	kg	*10330	*10330	*7350	6840	*5920	4240	*4360	2820	4330	2070	8.84
	lb	*22770	*22770	*16200	15080	*13050	9350	*9610	6220	9550	4560	(29.0)
3.0 m (10 ft)	kg		*8630	6210	*6450	3960		*5240	2710	4040	1890	9.13
	lb		*19030	13690	*14220	8730		*11550	5970	8910	4170	(30.0)
1.5 m (5 ft)	kg		*9550	5650	*6870	3700		*5360	2580	3990	1850	9.13
	lb		*21050	12460	*15150	8160		*11820	5690	8800	4080	(30.0)
Ground Line	kg	*8600	*8600	*9560	5370	*6920	3510	*5230	2490	*3840	1950	8.83
	lb	*18960	*18960	*21080	11840	*15260	7740	*11530	5490	*8470	4300	(29.0)
-1.5 m (-5 ft)	kg	*11450	10280	*8660	5310	*6390	3450	*4540	2470	*3390	2230	2.21
	lb	*25240	22660	*19090	11710	*14090	7610	*10010	5450	*7470	4920	(26.9)
-3.0 m (-10 ft)	kg		*6840	5400	*4980	3510						
	lb		*15080	11900	*10980	7740						

5.65 m (18' 6") 2-Piece Boom; 2.92 m (9' 7") arm equipped with 0.87 m³ (SAE heaped) bucket and 500 mm (20") triple grouser shoes.

Load point height m (ft)	Load radius								At max. reach			
	3.0 m (10 ft)		4.5 m (15 ft)		6.0 m (20 ft)		7.5 m (25 ft)		Capacity		Reach m (ft)	
												
9.0 m (30 ft)	kg			*3290	*3290					*4600	4260	6.28
	lb			*7250	*7250					*10140	9390	(20.6)
7.5 m (25 ft)	kg					*3530	*3530			*4030	2800	7.83
	lb					*7780	*7780			*8880	6170	(25.7)
6.0 m (20 ft)	kg			*5170	*5170	*4870	4510	*2440	*2440	*3800	2170	8.78
	lb			*11400	*11400	*10740	9940	*5380	*5380	*8380	4780	(28.8)
4.5 m (15 ft)	kg			*6720	*6720	*5540	4310	*4390	2860	*3740	1850	9.36
	lb			*14820	*14820	*12210	9500	*9680	6310	*8250	4080	(30.7)
3.0 m (10 ft)	kg	*12710	12080	*8080	6370	*6130	4020	*5040	2720	3690	1690	9.63
	lb	*28020	26630	*17810	14040	*13510	8860	*11110	6000	8140	3730	(31.6)
1.5 m (5 ft)	kg	*8700	*8700	*9240	5740	*6660	3720	*5240	2570	3640	1650	9.63
	lb	*19180	*19180	*20370	12650	*14680	8200	*11550	5670	8020	3640	(31.6)
Ground Line	kg	*9390	*9390	*9580	5360	*6880	3490	*5260	2450	*3610	1720	9.35
	lb	*20700	*20700	*21120	11820	*15170	7690	*11600	5400	*7960	3790	(30.7)
-1.5 m (-5 ft)	kg	*12500	10070	*9020	5230	*6570	3380	*4860	2400	*3270	1950	8.77
	lb	*27560	22200	*19890	11530	*14480	7450	*10710	5290	*7210	4300	(28.8)
-3.0 m (-10 ft)	kg	*10150	*10150	*7560	5270	*5530	3400					
	lb	*22380	*22380	*16670	11620	*12190	7500					

1. Lifting capacity are based on SAE J1097 and ISO 10567.

2. Lifting capacity of the HX series does not exceed 75% of tipping load with the machine on firm, level ground or 87% of full hydraulic capacity.

3. The load point is a hook located on the back of the bucket.

4. (*) indicates load limited by hydraulic capacity.

SPECIFICATIONS

HX220 L / NL

HX220 L

ENGINE	STD	OPT
Cummins QSB 6.7 engine	●	
HYDRAULIC SYSTEM		
Intelligent Power Control (IPC)		
3-power mode, 2-work mode, user mode	●	
Variable Power Control	●	
Pump Flow Control	●	
Attachment Mode Flow Control		●
Engine Auto Idle	●	
Engine Auto Shutdown Control		●
Electronic Fan Control	●	
CABIN & INTERIOR		
ISO Standard cabin		
Rise-up type windshield wiper	●	
Radio / USB player	●	
Handsfree mobile phone system with USB	●	
12 volt power outlet (24V DC to 12V DC converter)	●	
Electric horn	●	
All-weather steel cab with 360° visibility	●	
Safety glass windows	●	
Sliding fold-in front window	●	
Sliding side window (LH)	●	
Lockable door	●	
Hot & cool box	●	
Storage compartment & Ashtray	●	
Transparent cabin roof-cover	●	
Sun visor	●	
Door and cab locks, one key	●	
Mechanical suspension seat with heater	●	
Pilot-operated slidable joystick	●	
Console box height adjust system	●	
Automatic climate control		
Air conditioner & heater	●	
Defroster	●	
Starting Aid (air grid heater) for cold weather	●	
Centralized monitoring		
8" LCD display	●	
Engine speed or Trip meter/Accel.	●	
Engine coolant temperature gauge	●	
Max power	●	
Low speed/High speed	●	
Auto idle	●	
Overload	●	
Check Engine	●	
Air cleaner clogging	●	
Indicators	●	
ECO Gauges	●	
Fuel level gauge	●	
Hyd. oil temperature gauge	●	
Fuel warmer	●	
Warnings	●	
Communication error	●	
Low battery	●	
Clock	●	
Cabin lights		●
Cabin front window rain guard		●
Cabin roof-steel cover		●
Seat		
Adjustable air suspension seat with heater		●
Cabin FOPS/FOG (ISO/DIS 10262) Level 2		
FOPS (Falling Object Protective Structure) · ISO 3449 Level 2		●
FOG (Falling Object Guard)		●
Cabin ROPS (ISO 12117-2)		
ROPS (Roll Over Protective Structure)	●	

SAFETY	STD	OPT
Battery master switch	●	
Rearview camera	●	
AAVM (Advanced Around View Monitoring)		●
Four front working lights	●	
Travel alarm	●	
Rear work lamp		●
Beacon lamp		●
Automatic swing brake	●	
Boom holding system	●	
Arm holding system	●	
Safety lock valve for boom cylinder with overload warning device	●	
Safety lock valve for arm cylinder		●
Swing Lock System		●
Three outside rearview mirrors	●	
OTHER		
Booms		
5.68 m; 18' 8" Mono boom	●	
5.65 m; 18' 6" 2-Piece boom		●
8.2 m; 26' 11" Long reach		●
Arms		
2.0 m; 6' 7"		●
2.4 m; 7' 10"		●
2.92 m; 9' 7"	●	
3.9 m; 12' 10"		●
6.3 m; 20' 8" Long reach		●
Removable clean-out dust net for cooler	●	
Removable reservoir tank	●	
Fuel pre-filter	●	
Fuel warmer	●	
Self-diagnostics system	●	
Hi MATE (Remote Management System)	●	
Batteries (2 x 12 V x 100 Ah)	●	
Fuel filler pump (50 ℓ/min)	●	
Single-acting piping kit (breaker, etc.)		●
Double-acting piping kit (clamshell, etc.)	●	
Rotating Piping Kit		●
Quick coupler piping		●
Quick coupler		●
Boom floating control		●
One Pedal Straight Travel System		●
Accumulator for lowering work equipment	●	
Pattern change valve (2 patterns)		●
Fine Swing Control System		●
Tool kit		●
UNDERCARRIAGE		
Lower frame under cover (Additional)		●
Lower frame under cover (Normal)	●	
Track shoes		
Triple grouser shoes (600 mm; 24")	●	
Triple grouser shoes (700 mm; 28")		●
Triple grouser shoes (800 mm; 32")		●
Triple grouser shoes (900 mm; 36")		●
Double grouser shoes (600 mm; 24")		●
Double grouser shoes (700 mm; 28")		●
Track rail guard	●	
Full track rail guard high walker		●

STD = Standard
OPT = Optional

SPECIFICATIONS

HX220 L / NL

HX220 NL

ENGINE	STD	OPT
Cummins QSB 6.7 engine	●	
HYDRAULIC SYSTEM		
Intelligent Power Control (IPC)		
3-power mode, 2-work mode, user mode	●	
Variable Power Control	●	
Pump Flow Control	●	
Attachment Mode Flow Control		●
Engine Auto Idle	●	
Engine Auto Shutdown Control		●
Electronic Fan Control	●	
CABIN & INTERIOR		
ISO Standard cabin		
Rise-up type windshield wiper	●	
Radio / USB player	●	
Handsfree mobile phone system with USB	●	
12 volt power outlet (24V DC to 12V DC converter)	●	
Electric horn	●	
All-weather steel cab with 360° visibility	●	
Safety glass windows	●	
Sliding fold-in front window	●	
Sliding side window (LH)	●	
Lockable door	●	
Hot & cool box	●	
Storage compartment & Ashtray	●	
Transparent cabin roof-cover	●	
Sun visor	●	
Door and cab locks, one key	●	
Mechanical suspension seat with heater	●	
Pilot-operated slidable joystick	●	
Console box height adjust system	●	
Automatic climate control		
Air conditioner & heater	●	
Defroster	●	
Starting Aid (air grid heater) for cold weather	●	
Centralized monitoring		
8" LCD display	●	
Engine speed or Trip meter/Accel.	●	
Engine coolant temperature gauge	●	
Max power	●	
Low speed/High speed	●	
Auto idle	●	
Overload	●	
Check Engine	●	
Air cleaner clogging	●	
Indicators	●	
ECO Gauges	●	
Fuel level gauge	●	
Hyd. oil temperature gauge	●	
Fuel warmer	●	
Warnings	●	
Communication error	●	
Low battery	●	
Clock	●	
Cabin lights		●
Cabin front window rain guard		●
Cabin roof-steel cover		●
Seat		
Adjustable air suspension seat with heater		●
Cabin FOPS/FOG (ISO/DIS 10262) Level 2		
FOPS (Falling Object Protective Structure) · ISO 3449 Level 2		●
FOG (Falling Object Guard)		●
Cabin ROPS (ISO 12117-2)		
ROPS (Roll Over Protective Structure)	●	

SAFETY	STD	OPT
Battery master switch	●	
Rearview camera	●	
AAVM (Advanced Around View Monitoring)		●
Four front working lights	●	
Travel alarm	●	
Rear work lamp		●
Beacon lamp		●
Automatic swing brake	●	
Boom holding system	●	
Arm holding system	●	
Safety lock valve for boom cylinder with overload warning device	●	
Safety lock valve for arm cylinder		●
Swing Lock System		●
Three outside rearview mirrors	●	
OTHER		
Booms		
5.65 m; 18' 6" Mono boom	●	
5.65 m; 18' 6" 2-Piece boom		●
Arms		
2.0 m; 6' 7"		●
2.4 m; 7' 10"		●
2.92 m; 9' 7"	●	
Removable clean-out dust net for cooler	●	
Removable reservoir tank	●	
Fuel pre-filter	●	
Fuel single warmer	●	
Fuel dual warmer		●
Self-diagnostics system	●	
Hi MATE (Remote Management System)	●	
Batteries (2 × 12 V × 100 Ah)	●	
Fuel filler pump (50 ℓ/min)	●	
Single-acting piping kit (breaker, etc.)		●
Double-acting piping kit (clamshell, etc.)	●	
Rotating Piping Kit		●
Quick coupler piping		●
Quick coupler		●
One Pedal Straight Travel System		●
Accumulator for lowering work equipment	●	
Pattern change valve (2 patterns)		●
Fine Swing Control System		●
Tool kit		●
UNDERCARRIAGE		
Lower frame under cover (Additional)		●
Lower frame under cover (Normal)	●	
Track shoes		
Triple grouser shoes (600 mm; 24")	●	
Triple grouser shoes (700 mm; 28")		●
Triple grouser shoes (800 mm; 32")		●
Triple grouser shoes - H / Chassis (600 mm; 24")		●
Track rail guard	●	
Full track rail guard		●

STD = Standard
OPT = Optional

- * Standard and optional equipment may vary. Contact your Hyundai dealer for more information.
The machine may vary according to International standards.
- * The photos may include attachments and optional equipment that are not available in your area.
- * Materials and specifications are subject to change without advance notice.
- * All imperial measurements rounded off to the nearest pound or inch.
- * The air conditioning system on this machine contains the fluorinated greenhouse gas refrigerant HFC-134a (Global Warming Potential = 1430).
The system contains 0.65 kg of refrigerant which has a CO₂ equivalent of 0.9295 metric tonne.

 **HYUNDAI CONSTRUCTION EQUIPMENT**

PLEASE CONTACT

Hyundai Construction Equipment Europe nv

Hyundailaan 4, 3980 Tessenderlo, Belgium **Tel:** (32) 14-56-2200 **Fax:** (32) 14-59-3405

www.hyundai.eu

EN - 2017.11 Rev 5
